



**KOHONEN SOM WITH CONSCIENCE FUNCTION
NEURAL NET BASED ENERGY EFFICIENT
CLUSTERING AND ROUTING WIRELESS SENSOR
NETWORKS**

إستخدام كوهينين مع دالي الضمير العصبونية لتوفير الطاقة وذلك بإيجاد

نموذج محسن للعنقدة والتوجيه اللاسلكي للشبكات

Prepared by

Saad Al-Azzam

Supervised by

Prof. Reyadh Shaker Naoum

**A Thesis Submitted in Partial Fulfilment of the
Requirements for the Master Degree
In Computer Science**

**Department of Computer Science
Faculty of Information Technology
Middle East University**

Amman – Jordan

January 2014

AUTHORIZATION STATEMENT

I'm Saad Alazzam, I give the authorization for my university "Middle East University", to distribute and provide hard or/and electronic copies from this thesis for any concerned educational institution, to be used for scientific studies and researches on demand.

Name: Saad Al-azaam

Date: 17/1/2015

Signature:



التفويض

أنا سعد العزام .. أعطي التفويضات لجامعتي - جامعة الشرق الأوسط - لتوزيع الرسائل وتزويد الجهات التعليمية المهمة بموضوع البحث بنسخ ورقية أو/و إلكترونية منها حال طلبها من الجامعة.

الأسم: سعد العزام
التاريخ: 2015 / 11 / 17
التوقيع: 

Examination Decision of the Committee

This is to confirm and verify that the thesis with the title "ENHANCING Wireless Sensor Network (WSN) Using Kohonen Self Organizing Mapping (KSOM) with conscience function neural In terms of Energy Consumption" was defined and accepted successfully ON 25 / 1 / 2015.

Examination Committee Members

1-Sadeq ALHamouz (Supervisor & Chairman)
Associate Professor
Faculty of Information Technology

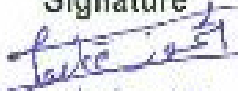
Signature

25/1/2015

2- Dr. Oleg Viktorov , (Member)
Computer science



3- Prof. Riyad AL-Shalabi , (external Member)
Dean of Scientific Research and Graduate Studies
Amman Arab university

25/1/2015

ACKNOWLEDGMENT

I utilize this opportunity to thank everyone helped me reach this stage and everyone who encourage me during performing this thesis. I want to thank Prof. Reyadh Shaker Naoum for his guidance and supervision during writing this thesis. Extended thanks are also for my family and friends who encourage me during writing this thesis. I also want to thank everyone who believes that the knowledge is right for everyone.

Table of Contents

KOHONEN SOM WITH CONSCIENCE FUNCTION NEURAL NET BASED ENERGY EFFICIENT CLUSTERING AND ROUTING WIRELESS SENSOR NETWORKS	I
AUTHORIZATION STATEMENT.....	II
التفويض.....	III
EXAMINATION DECISION OF THE COMMITTEE	IV
ACKNOWLEDGMENT.....	V
ABSTRACT	X
ملخص الرسالة	XII
1 INTRODUCTION	1
1.1 BACKGROUND.....	2
1.2 PROBLEM STATEMENT	3
1.3 AIMS AND OBJECTIVES	4
1.4 RESEARCH METHODOLOGY	4
1.5 RESEARCH MOTIVATION.....	5
1.6 CONTRIBUTION	5
1.7 THESIS OUTLINES	6
2 RELATED WORKS.....	7
2.1 BACKGROUND.....	8
2.2 RELATED WORKS.....	8
2.3 SUMMARY.....	30
3 METHODOLOGY AND SYSTEM IMPLEMENTATION	32
3.1 OVERVIEW	33
3.2 RESEARCH METHODOLOGY	33
3.3 PROPOSED ALGORITHM.....	34
3.3. 1 Setting up the Clusters stage.....	34
3.3. 2 Determining the CH	38
3.3. 3 Transmission Stage.....	39
3.4 SUGGESTED SCENARIOS.....	42
3.4.1 Clustering of WSNs Using Kohonen SOM.....	42
3.4.2 Clustering of WSNs using Kohonen SOM with Conscience Function	46

3.5 NEURAL NETWORK IN WSN	49
4 RESULTS AND DISCUSSION	50
4.1 OVERVIEW	51
4.2 FIRST PART: RESULTS FOR SOM AND KSOM ALGORITHMS	51
4.3 SECOND PART: PERFORMANCE OF WSNs WITH CONSCIENCE FUNCTION	54
4.4 EVALUATION	57
5 CONCLUSION AND FUTURE WORKS	60
5.1 CONCLUSION REMARKS	61
5.2 FUTURE WORKS	62
5.3 PUBLICATIONS	62
REFERENCES	64

TABLE OF FIGURES

Figure 2. 1 architecture of the suggested technique, (Srinivasan and Murugappan, 2013).	13
Figure 2. 2: Block diagram of the suggested technique, (Chakravarthi, 2012).....	14
Figure 2. 3: SOM NN model with 20 outputs and 4 inputs (Veena and Kumar, 2012).	16
Figure 2. 4: CELRP model in WSNs (Nurhayati and et al, 2011).....	18
Figure 2. 5: the model of the suggested scheme, (Khan, 2007).	26
Figure 2. 6: the structure of COMUT network, (Karenos and et al, 2007).	27
Figure 3. 1: Main stages for the proposed scheme.	33
Figure 3. 2: Topology structure of SOM for the proposed scheme.	36
Figure 3. 3: MSE in NN	41
Figure 3. 4: Flowchart of SOM in WSNs	42
Figure 3. 5: Flowchart of KSOM in WSNs	46
Figure 3. 6: Flowchart of KSOM with Conscience function	48
Figure 3. 7:Relation between NN and WSN	50
Figure 4. 1: Simulation scenario	52
Figure 4. 2: Average lifetime for both kohenon and KSOM algorithms	52
Figure 4. 3: Average energy for both Kohenon and KSOM algorithms.	53
Figure 4. 4: The average lifetime for the WSN considering several numbers of nodes	55
Figure 4. 5: Average lifetime considering several nodes number	56
Figure 4. 6: Average energy for Kohenon, KSOM and KSOM with Conscience function.	57
Figure 4. 7: Network lifetime at 400 nodes	58
Figure 4. 8: Network lifetime at 800 nodes	59
Figure 4. 9: Network energy consumption at 400 nodes	59
Figure 4. 10: Network energy consumption at 800 nodes	60

ABBREVIATIONS

Abbreviation	Key Words
WSN	Wireless Sensor Network
NNs	Neural Networks
SOM	Self Organization Mapping
KSOM	Kohenon Self Organization Mapping
LEA2C	Low Energy Adaptive Connectionist Clustering.
LEACH-C	Low-Energy Adaptive Clustering Hierarchy Centralized.
CH	Cluster Head
CBRP	Cluster Based Routing Protocol
BS	Base Station
HMM	Hidden Markov Model
EKMs	Extended Kohenon Maps
CELRP	Cluster Based Energy Efficient Location Routing Protocol.
PDF	Probability Density Function
CN	Contender Network
SVM	Support Vector Machine
PSO	Particle Swarm Optimization
TDMA	Time Division Multiple Access
AHP	Analytic Hierarchy Process
GT	Growth Threshold
OW	Old Weight
NW	New Weight
COMUT	Congestion Control for Multi-class Traffic
TECARP	Tree based Energy and Congestion Aware Routing Protocol
MWSN	Mobile wireless Sensor Network
TS-TDMA	Time Sharing Time division Multiple Access
CONCERT	Congestion Control for Sensor Networks
CONWISE	Congestion Control from Sink to Sensors

**NEURAL NET BASED ENERGY EFFICIENT CLUSTERING AND
ROUTING WIRELESS SENSOR NETWORKS**

Prepared by

Saad Al-Azzam

Supervised by

Prof. Reyadh Shaker Naoum

Abstract

The current development within communication field lead to continuous and urgent needs for new data transfer techniques that can perform the communication process with high performance . WSN emerged recently as a common and significant type of network which can be used within the environment that cannot be continuously managed by the human being. To enhance WSN performance in terms of several criteria, including; lifetime and energy, then several procedures can be employed, such as; clustering. KSOM was emerged as a technique for clustering in WSN. The aim of this thesis is to evaluate the WSN performance in terms of average lifetime and consumed energy after adding conscience function of neural network. The system is simulated in MATLAB software environment. The performance was evaluated in two stages, the first stage investigate and compare the

performance for Kohenon and KSOM, and the second stage investigates the effect of adding conscience function of neural network to the KSOM.

The results confirmed the effectiveness of KSOM and it is improvement for both energy consumption and network lifetime in comparison with Kohenon technique. Furthermore the conscience function of the NN will in turns enhance the performance of the WSN over KSOM algorithm, and hence over SOM algorithm. KSOM achieved an enhancement of 30.7% and 2.22% over Kohenon algorithm in terms of Lifetime and average energy respectively at 400 nodes number. Furthermore, enhancements of 13.33% and 3.03% were achieved due to applying conscience function in terms of average lifetime and average consumed energy respectively at 200 nodes.

ملخص الرسالة

إستخدام كوهينين مع دالي الضمير العصبونية لتوفير الطاقة وذلك بايجاد نموذج

محسن للعقدة والتوجيه اللاسلكي للشبكات

إعداد

سعد العزام

اشراف الاستاذ الدكتور

رياض شاكر نعيم

نتيجة التطور الحالي في مجال الإتصالات , هناك حاجة ملحة ومستمرة لتقنيات جديدة يمكن من خلال انجاز عملية الاتصال بطريقة تعطي نتائج عالية. ظهرت في الآونة الأخيرة شبكة الاستشعارات اللاسلكية WSN كأحد انواع الشبكات الشائعة والمستخدمه في البيئات التي لا يمكن أن تدار بشكل مستمر من قبل الانسان. تعزيز اداء WSN بالنسبة لعدة معايير, كالعمر الزمني وكمية الطاقة المستهلكة, يتم باستخدام عدة طرق منها التجميع. تعتبر KSOM أحد اهم الطرق الشائعة الاستخدام كأسلوب للتجميع. الهدف العام من هذه الرسالة هو تقييم أداء شبكة الاستشعار اللاسلكية بناء على معياري الطاقة المستهلكة ومدة الحياة بعد إضافة Conscience function للشبكة العصبية. تمت محاكاة النظام المقترح باستخدام برنامج الماتلاب. تم تقييم الأداء على مرحلتين، المرحلة الأولى مقارنة أداء ل Kohenon وKSOM، والمرحلة الثانية تقييم لتأثير إضافة Conscience function للشبكة العصبية إلى KSOM.

بعد تنفيذ البرنامج المتعلق بالنظام المقترح, تأكدت اهمية وفعالية KSOM في تحسين أداء WSN بناء على المعايير التي تم اختيارها وهي مدة الحياة والطاقة المستهلكة. تبين أن KSOM تتفوق في الأداء على SOM الاعتيادية, وتبين أيضا أن اضافة ال Conscience function ينتج عنه تحسين في أداء الشبكة بشكل أفضل من الحالتين السابقتين. حققت KSOM تحسين مقداره 30.7% و 2.22% بناء على معياري مدة الحياة والطاقة المستهلكة بالترتيب مقارنة مع Kohonen عند عدد من النقاط داخل الشبكة العصبية يساوي 400 نقطة. وأيضاً, عند 200 نقطة, اضافة ال Conscience function للشبكة العصبية نتج عنه تحسين مقداره 13.33% و 3.03% بناء على معياري مدة الحياة والطاقة المستهلكة بالترتيب مقارنة مع KSOM.

1 INTRODUCTION

CHAPTER ONE

1.1 Background

It is noticeable that there is a great revolution occurred recently within "Wireless Sensor Networks (WSNs)". This type of communication technology is now deployed within several life applications, such as; military and intrusion detection. Within this technology; the collection of data is attained from several locations through physical phenomena interaction in addition to the collaborative efforts that is provided by the special devices characterized with low cost. The WSNs is formed via combining very large number of sensors within typical area. All of these nodes own their individual processor, energy source, at least one sensor that sense the environment changes, such as temperature and motion in addition to wireless interface for the communication purposes (Aslam et al, 2011).

The communication process within this type of networks is achieved via firstly sensing the data by the sensors. After that, some processing on the sensed data including compression and quantization is performed. The next step is to either transfer the data immediately to BS on through some relay nodes. Usually there is a limitation within the attainable resources that include computational capacity, storage and energy. The main source of energy within WSNs is wireless communication. So; it is recommended and required to attain an effective structure for the network topology in addition to effective protocols that manage the data exchange process. Clustering approach has been extensively deployed during the last years within WSNs (Aslam et al, 2011).

This process is recognized as the procedure that is used in order to make groups from the sensor nodes; these groups are called clusters. A "Cluster Head (CH)" is deployed within each cluster in order to attain the coordination and management for the nodes within related cluster in addition to facilitate the communication process with "Base

Station (BS)". Clustering process is also effective in achieving better management for the energy consumption and hence increasing the network lifetime. The energy saving process is obtained due to node permission to switch between active and sleep states (Aslam et al, 2011).

1.2 Problem Statement

A great revolution occurred recently within communication field including WSNs. WSNs have been recently deployed within several practical and critical life applications and fields. However; the limited energy is one of the most common and significant challenges that occurred within WSNs. When the node consumed its available energy, then it will die and loose its ability to communicate where this in turn affects on the communication process for the whole network. Applying clustering algorithms will enhance the energy consumption and increase the lifetime for the WSNs (Ramadana.et al, 2013)

The clustering process should be performed in an effective procedure in order to achieve the best performance in terms of network lifetime and consumed energy. During the clustering process, several steps must be performed, where the most significant stage is the choice of Cluster Heads (CHs) within each cluster. This selection must be fair and based on specific criteria. Kohonen SOM is an effective clustering approach especially when it is combined with Conscience Function of Neural Networks.

1.3 Aims and Objectives

This thesis aims to introduce a clustering approach within WSNs including the selection of CH based on Kohonen SOM with Conscience Function of Neural Networks. Several objectives are predicted to achieve during this thesis, which are;

- ✚ Understanding the main concepts of Wireless Sensor Networks (WSNs)
- ✚ Understanding the main concepts of Neural Networks (NNs).
- ✚ Analyzing the process of data transmission in WSNs.
- ✚ Recognizing the training process of NNs.
- ✚ determining the protocols that can be deployed in order to manage the process of data exchange between BS and nodes.
- ✚ Understanding the Kohonen SOM approach.
- ✚ Defining the Conscience Function of Neural Networks.
- ✚ Determining the steps that are followed in CH selection.

1.4 Research Methodology

The methodology that will be followed during this thesis can be summarized as follows; first of all the whole communication process will be performed within three main stages; setting up clusters, selecting CH and transmitting data transmission stages. In the first stage, the Kohonen SOM approach is trained using a clustering technique; k means clustering technique to get a low dimensional representation of input space that is called map. The clustering approach categorizes the network nodes into homogenous k clusters in which nodes that are similar to each other are grouped in the same cluster. In the Kohonen SOM algorithm, two parameters are used as inputs for this approach; energy level and network space which called x and y. This resulted in a matrix with nx3 dimensions, where n represents the number of nodes in the network; 1000 nodes.

The CH selection will be mainly based on the maximum level of energy, distance to the BS and distance to the centroid of the cluster. These three criteria will be combined together within this thesis in order to effectively and successfully select the CH which in turns will ensure that the lifetime of WSNs will be increased and the energy consumption will be effectively managed. After selecting the CHs for all clusters; the nodes will start sending the sensing data to the CH which in turns aggregate them from all nodes within related cluster and then transfer them again to the BS. The CH will be continuously adjusted after each transmission phase in order to prevent any single node from totally manage or control the WSNs.

1.5 Research Motivation

As mentioned previously, the WSNs are widely used within several practical applications in the life. The procedure that will be followed during this thesis will try increasing the lifetime of nodes and enhance the consumption of energy as much as possible. Increasing the lifetime of whole networks will be effective in increasing the adoption for this technology in addition to increase the user satisfaction to deploy it over the remaining types of communication technologies. WSNs has a great deal of importance due to it is applicability within several critical fields, such as military and industry.

1.6 Contribution

The main research's contributions can be summarized as follow;

- Enhance SOM method by adding epsilon value that control current weights and previous weight values to insure that NN operates in convergence mode, not a divergence one, also for stability in the system, 10^{-6} is accepted value.

- Combining cost function for NN to choose CH in KSOM, this tool will be done based on distances for nearest and farthest sensors to BS, distances for nearest and farthest sensors to Centroid point to each cluster, freq. of choosing CH and changing in energy to each sensor, all these parameters are done to each cluster at each time slot.
- Adding Conscience to KSOM add another point of choosing CH based on bias not only energy.

1.7 Thesis Outlines

The first chapter from this thesis is an introduction for the WSN and it is concepts in addition to the aims, objectives, problem statement, research motivations and the methodology that will be followed during the implementation of the proposed system.

The remaining of the thesis is organized as follow;

Chapter Two: introduces some of the recent works that are related to the WSNs and KSOM algorithm.

Chapter Three: investigates the research methodology in details aided with all needed equations and flowcharts.

Chapter Four: introduces the results that were obtained after simulating the proposed system in MATLAB simulator and running its code. The results are introduced into two stages, which are; comparison between the performance of Kohonen and KSOM algorithms and comparison between KSOM and KSOM with conscience function of NNs. The lifetime and average energy are used as performance criteria during the investigation.

Chapter Five: introduces a conclusion for the whole work in addition to some key points suggested as future works to enhance system performance.

2 RELATED WORKS

CHAPTER TWO

2.1 Background

The great revolution that occurred during the last few years in communication led to the use of smaller size equipment during the communication process. This in turn led to the use of small size of batteries needed to operate these components. As mentioned previously, the development of WSNs rises from the difficulty of accessing some places and environment by human being, this in turns means the dead nodes recharge with energy is also not easy to be performed. Another essential requirement is related to the WSNs applications in which a continuous control and management are required. So as a result, the network coverage and lifetime are considered essential concerns because the lifetime of the WSN is considered an essential performance criterion. Furthermore, during WSNs designing; the conservation of the energy is considered critical and essential issue. This conservation must be achieved energy resources management in wise manner (Enami et al, 2010). This chapter introduces some of the recent works and studies that are related to the WSNs with some concentration on the conservation of energy within these networks employing several methods as will be investigated latterly.

2.2 Related Works

According to Bhuvana (2014), the clustering process is referred to the process that is employed in gathering and combining the objects within different groups based on specific criteria. Generally, the characteristics for the objects within the same group are common, while the objects within different clusters have different characteristics. SOM has been employed during their investigation as clustering algorithm. A flower clustering for several arrays with two dimensions has been specifically considered. SOM was mainly used for classification purposes; so topological information will be

the result for the performed classifications. They dedicated that SOM is able to be generated including any required details level.

Four attributes of flowers have been mainly employed as the SOM inputs. SOM will in turns converts these inputs into neuron layer with two dimensions. The training input class vectors have been computed through SOM. A matrix of size 64*150 will be the output of the considered network. Furthermore; each flower classes has been also calculated through SOM hits in addition to clarifying the flowers number related to each class within the network. In case that the neuron area has large hits number; then the class is considered to introduce similar and high regions related to the space of features. MATLAB 7.12.0 has been employed to simulate their investigation. The results demonstrated that in case of larger number of the considered arrays; both the neurons weight and topology are increased (Bhuvana, 2014).

Rakocevic (2013) demonstrated that Kohonen SOM which is also recognized as Kohonen NN is considered one of the common methods that are used for clustering. This approach is considered as a simulation for the methods that are used within cerebral cortex in order to perform the data classification and organization. By applying this approach; there is ability to make groups as a classification for the data. Within SOM; the data classes are not needed dissimilar to "Back Propagation NN". This will in turns be a benefit to apply SOM within WSNs. Regarding to the formation of SOM; several nodes are included within it. Specific values of weights are assigned to the nodes these weights have length equal to the length of input vector.

In case that there is a processing for new data within the WSNs; each one nodes specify the Euclidian distance between weight vector and input which in turns considered as output. The winner node is that node that own smallest Euclidian

distance. They introduced a novel method which permits the distribution process for specific messages number that is required to be exchanged between nodes. This has been achieved via evaluating the distance that separates the node from the winner node without any need for a communication with complete network. They also introduced a solution that is able to treat with sensor data changing that is occurred due to two main reasons, which are; causing event type and it is location. The results demonstrated that these approaches are effective to be applied within the organizing data without considering communication within complete network (Rakocevic, 2013).

Chaczko and et al (2013) introduced a novel approach aimed to achieve the managing for WSNs that are characterizes with feature mapping of type SOM. They based on using "Extended Kohonen Maps (EKMs)" in order to perform their work. They demonstrated that EKMs is considered one of the common and effective approaches that have been successfully applied within several fields, such as feedback missions. The generalization facility of feature map bases mainly on self-organization that is performed through training. Quantitative investigation has been used in order to ensure the ability of EKM for performing self-organization and categorizing based on input space to finally achieve the administration for WSNs in terms of clustering and routing functions.

The results illustrated that indirect mapping which is mainly based on EKMs will result in better feedback and control in comparison with these mapping approaches which are direct. The result also demonstrated that the process convergence can be performed in faster way. A better management for the routing and clustering processes within WSNs can be achieved and improved when applying the process of self-organization that is based on EKMs. This will in turns result in enhancing the adaption

of the WSNs for the probable changes in environment conditions (Chaczko and et al, 2013).

Desieno (2013) studied the effect of adding conscience functions in NN and how it enhances the process of competitive learning. They demonstrated that competitive learning approaches has several attractive advantages that encourage applying them in NN; the quantization of input vector is considered one significant advantage. In this process; the input vector is divided into discrete regions with equal probability. The processing elements are latterly used for the divided region representation. In case that the tow input vectors have the same probability for falling within a region; subsequently the only one node from the N nodes will be generated by processing element intended for input vector.

It is noticeable that the learning based on Kohenon approach suffering from the drawback of large needed number of iterations that are needed for the purposes of network learning until achieve the target solution. Usually; the approaches prefer increasing the convergence needed iterations via including the losing elements within the solutions. Final regions may be distorted in the direction of input vectors average by the slow adjusting for loser's weights (Desieno, 2013).

The idea behind conscience mechanism lies in including all obtainable processing elements within the solution as quick as possible and then directing the process of competition in such way that there is ability for the processing elements for competition winning. Two parts are mainly included within conscience approach, which are; competitive layer output generation and weight vectors adjusting process. Their works was aimed to enhance the description of "Probability Density Function (PDF)"

for Kohonen approach. The results demonstrated that this applying this model can be effectively improves the learning process of NN (Desieno, 2013).

According to Faheem and et al (2013), there are several optimal routing protocols that used within WSNs to increase the lifetime of these networks. In this study, two main types of routing protocols that based on clustering have been compared, these protocols are; SFRP and ECDGP. The comparison was based on congestion along with lifetime of the network and consumption of energy, delay, overhead of metrics and “Packet Delivery Ration (PDR)”. Three models have been used in this study for WSN which are; application model, network model and the model of radio energy. The obtained results from the simulation showed that the lifetime of sensor and energy dissipation are affected by PDR, overhead and delay. Routing protocols can be considered as an efficient and good quality protocols based on the selection of routing path and data fusion. Furthermore, the results showed that ECDGP has outweighed on SFRP protocol in the PDR, lifetime of network, consumption of energy and delay terms.

According to Srinivasan and Murugappan (2013), the traffic of upstream nodes can be categorized depending on hybrid delivery, query based, continuous based and event based. Due to the nature of many-to-one, the congestion increased within the traffic of upstream nodes. The amount of energy consumption is increased with the congestion, so a reliable and efficient protocol is necessary to control the consumption of energy. Furthermore, two main kinds of reliability are presented; packet reliability and hop-by-hop reliability, in this study a technique of packet reliability has been suggested to perform reliable transfer of data. This technique involves; token that based on the transmission data, hash function and reliability index. The reliability of energy and throughput has been measured during the simulation experiments. Figure 2.1

illustrates the architecture of the suggested technique and the calculation of hash function.

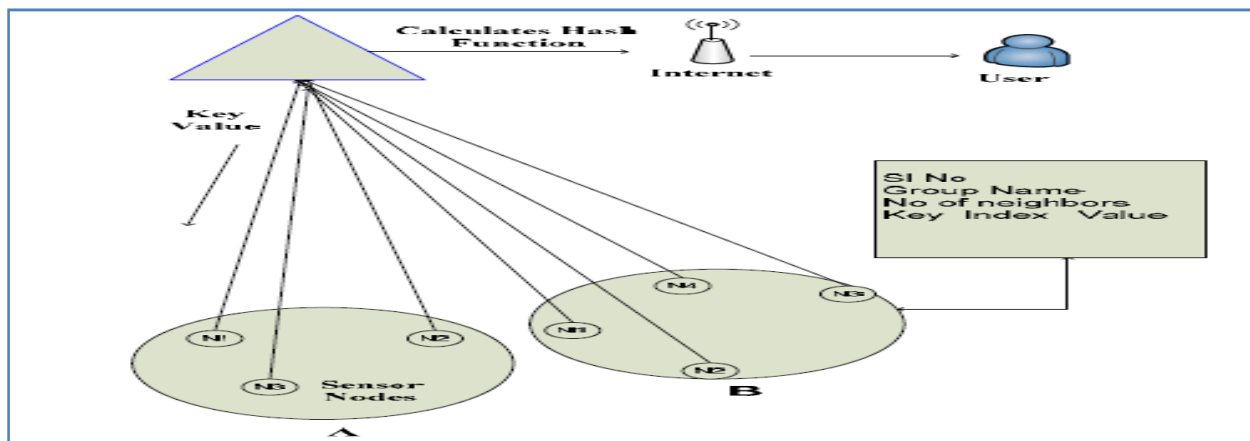

Figure 2. 1 architecture of the suggested technique, (Srinivasan and Murugappan, 2013).

According to Chakravarthi (2012), the congestion that occurred through WSNs has a great impact on the network performance. The load of network in the idle state is too low; however, this load increased and became very high when the events are occurring and this will cause the congestion. For this issue, the Controller of Fuzzy Logic has been used and applied to monitor the congestion, which is detected based on the computed degree of congestion. So, if the computed degree is larger than the threshold, then there is an occurred congestion. However, if this degree is lower than the threshold, then there is no congestion within the network. Furthermore, a signal of congestion notification will be forwarded to the middle nodes in the congestion occurred case. Thus, the signaling of “Implicit Congestion Notification (ICN)” will be utilized for this objective. The rates of transmission for the nodes will be adjusted based on the received signal of congestion notification. Figure 2.2 illustrates the suggested technique architecture.

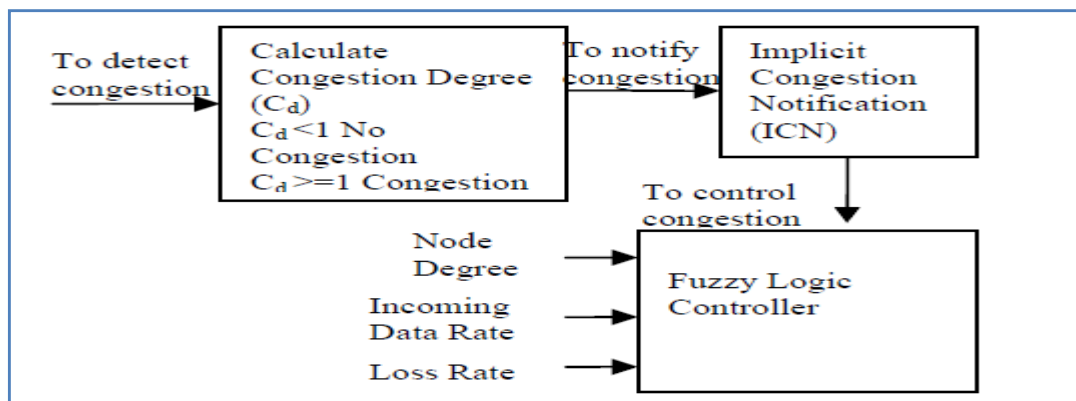

Figure 2. 2: Block diagram of the suggested technique, (Chakravarthi, 2012).

Azimi and Ramezanpor (2012) demonstrated that "Cluster Based Routing Protocol (CBRP)" is considered one of the most commonly used approaches that are used for the purposes of increasing the lifetime of the network. This extending is achieved via separating the nodes within WSNs into clusters. After that; an election is performed within the network in order to determine the cluster head which is mainly responsible about combining the nodes data and then transfer them toward "Base Station (BS)". They demonstrated that several approaches occurred in the literatures that are mainly based on CBRB. These approaches mainly depend on topological neighborhood as a process to forming the clusters. During their works; they introduced an approach that is mainly based on using SOM NN.

Regarding to the SOM weights; they have based on applying some nodes that have maximum values for energy. By these nodes; the nodes which have lower values of energy will be attracted. This mean that the cluster could be able to established without adjacent nodes. By using this novel approach; the clusters that are balanced in energy can be easily formed which in turns mean that the energy consumption is distributed equally between clusters. Furthermore, they also introduced a novel cost

function that is in turns able to perform the election process for the cluster heads of the nodes inside WSNs. The election is performed in energy efficient procedure since it combines between several useful criteria. Their results demonstrated that the two introduced approaches are preferable over the previous approaches in literature related to the same topic due to the enhancing of lifetime in addition to maintaining the network coverage (Azimi and Ramezanpor, 2012).

Veena and Kumar (2012) introduced a new method for the purposes of clustering. Their approach is concerned with the applying fuzzy logic for the parameters of sensor node. They have based on "SOM NN (SOM-NN)" in order to effectively perform the clustering process. They demonstrated that the KSOM is considered one of the most common types of feed forward and competitive NN that are based on unsupervised training. SOM-NN characterizes with the ability of self organizing and unsupervised learning. The weights are selected randomly and assigned values within the range (0, 1). By this approach, the relationship among output and input can be concluded in case of additional inputs are added. A model for SOM NN is illustrated below in Figure 2.3.

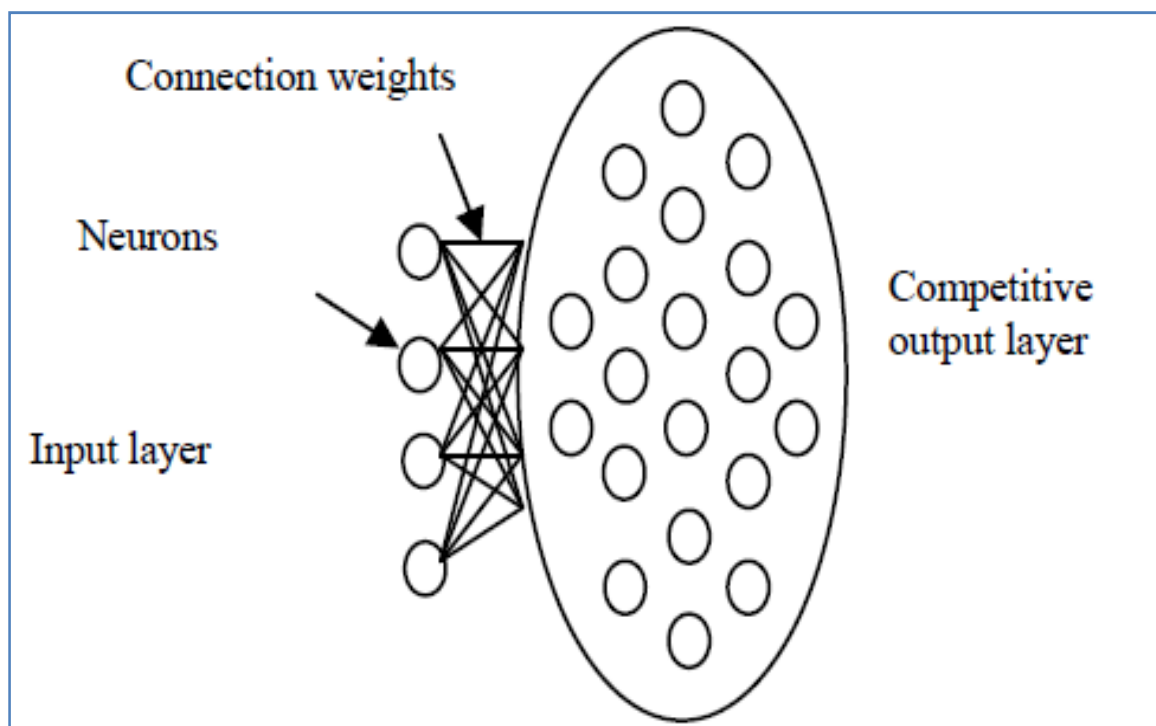

Figure 2. 3: SOM NN model with 20 outputs and 4 inputs (Veena and Kumar, 2012).

The evaluation for the suitability of sensor node for specific applications has been determined using "Hidden Markov Model (HMM)". It is considered one of the common statistical methods that is mainly modeling the system assuming Markov approach by means of hidden or unobserved cases. They have performed several cases of simulation based on selecting different values for the network parameters in order to estimate the efficiency of the proposed approaches (Veena and Kumar, 2012).

Mannan (2012) demonstrated that SOM is considered an example for the unsupervised learning approaches which is enthused from the neuron physical arrangement inside brain of the human. It possibly could be up to three dimensions based on how much the prediction or recognition mission is complex. The neurons within the NN can be organized in several cases and positions, such as; hexagonal, grid or randomly. This arrangement occurred previous to the training process. He also

demonstrated that the learning process of NN is strongly affected by the network topology. The last organization for the neurons also plays an essential role. During the SOM training process; the target classes' exact definition is not recognized while their number is already defined.

The idea of his work rises from the limited lifetime for the battery power; an additional power is needed in order to transfer the data between nodes of WSNs. They tried to enhance this lifetime via introducing a new system depends mainly on using SOM NN. Through this approach; the nodes inside WSNs will be permitted to transfer the data. A "Base Station (BS)" of type 2*3 SOM will be used to receive this transfer data. BS latterly categorizes these data within several classes. The transmission for data from several active nodes will result in training the SOM. After that; the definition of class will be broadcasted by BS to the active nodes within network. The results demonstrated that this system is able to enhance the power saving for the power by approximately 48.5% (Mannan, 2012).

According to Tasdemir and Merényi (2012), an essential role is played by visual representation of the data set that characterizes with high dimension using low dimensions. This process is effective in the clustering classification and discovery. They dedicated that SOM is considered one of the powerful and effective tools that can be employed for the purposes of interactive and explanatory visualization. Through this technique; the visualization for various information related to the similarity including; topology, prototype distance and distribution can be enabled without affecting the dimensions of the features. They compared evaluated the SOM capabilities in addition to another 2D data visualization that is based on the graph called CONNvis. The results

for their investigation and evaluation demonstrated that maximum amount of information content is transferred when using conscience SOM learning.

Nurhayati and et al (2011) demonstrated that the generation of the most appropriate and effective energy approach within WSNs is considered one of the most essential and significant issues that must be addressed within this type of networks. This importance rises from the nature of WSNs; since the network is established via connecting set of nodes or deices that characterizes with small power for the batteries. Furthermore; they demonstrated that the routing protocols are mainly used for the energy efficient employing and battery lifetime extending. Regarding to the traditional approach that is used for the purpose of nodes clustering within WSNs; it also considered significant element in order to conserve the energy.

A "Cluster Based Energy Efficient Location Routing Protocol (CELRP)" has been proposed within their paper in order to address the mentioned problems and issues in WSNs. The routing process for the proposed scheme is performed based on the node clustering in addition to the node of "Cluster Head (CH)". CELRP model is illustrated below in Figure 2.4 (Nurhayati and et al, 2011).

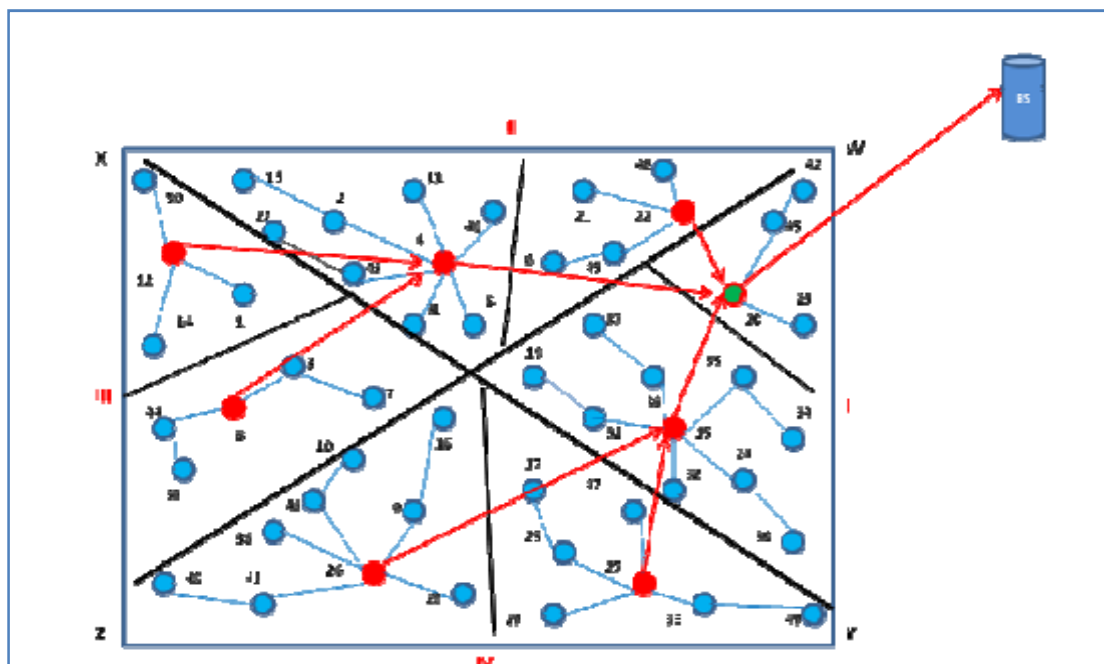

Figure 2. 4: CELRP model in WSNs (Nurhayati and et al, 2011)

As illustrated in Figure 2.4, the network is divided into several clusters; each cluster has its own CH and only one leader CH for the overall WSNs. The BS location is far from the sensors. The CH node is selected by BS and aimed to receive the data from all nodes within its cluster and then to transfer it again to the leader CH for the whole WSNs. The simulation demonstrated that CELRPP model is very efficient in conserving energy and it has better performance than other protocols which have been previously used for the same purposes; such as; "Base Station Controlled Dynamic Clustering Protocol (BCDCP)" (Nurhayati and et al, 2011).

According to Cherian and Nair (2011), there are various priority levels of sensor network data. So, to achieve real time transmission, this required to higher rates of transmission and reliable delivery of information. In this study, an algorithm of multipath routing has been suggested to allow the reliable data delivery. Routing via multi-paths required to establish several paths between the node of the source and the node of the destination. The suggested algorithm based on modifying the length of

queue to avoid packet drops at nodes of the path. Also, this algorithm offers traffic smoothness and prevents the clustering of the packet. The congestion control and flow control have been controlled and managed by controlling and monitoring the rate of scheduling. The obtained results showed that this algorithm is not constant (dynamic), where the sensor nodes output rate is modified based on the conditions of the network. Also, this work can be improved by using the algorithm of admission control, which supported the congestion management in burst traffic case.

According to Jabbar and et al (2011), the low amount of energy and the congestion are the main causes of network delay. So, the available recourses should be used in an appropriate manner. In this study, the “Congestion Control Protocol (CCP)” has been suggested for “Mobile wireless Sensor Network (MWSN)”. This protocol utilized many techniques to provide efficiency, preserve energy and prevent congestion. “Time Sharing Time division Multiple Access (TS-TDMA)”, Statistical TDMA and TDMA are the main used techniques within this protocol. By this scheme, a number of mobile nodes have been distributed within x and y coordinates.

These nodes are gathered in many clusters with fixed “Cluster Head (CH)”. The CH used to authenticate the nodes that involved within the clusters through the ratio of distance for the neighboring CHs. TDMA, TS-TDMA and STDMA have been applied and compared. NS-2.27 has been used to implement the work and the function of GNUPLOT has been used to derive the graphs. The obtained results showed that the technique of TS-TDMA was the most optimal solution for network efficiency, CH and mobile node delay, consumption of energy, latency and congestion problems (Jabbar and et al 2011).

Vijayaraja and Hemamalini (2010) suggested the “Congestion Control for Sensor Networks (CONCERT)” approach to minimize the data travelling amount within the network. Based on the level of congestion at the collective nodes, CONCERT approach changes the aggregation degree for the packets of data. Grouping the data can minimize the traffic amount and this leads to minimize the congestion within the network. Furthermore, the adaptive aggregation is able to partially solve the problem of congestion and this refers to the aggregation degree restricts. The travelled information among WSN can be lost if the aggregation restricts increased. Moreover, the advanced data collective may need too much processing, thus too resources of energy. The approach of CONCERT is utilized as a supplement for the other methods of congestion control.

Das (2010) proposed the mechanism of fusion, which ensures that congested nodes receive prioritized access to the channel. A typical carrier sense multiple access layer gives all nodes the same chance to compete for channel access. The parent node may gather traffic from several children nodes, tends to overflow if it does not have more chances to transmit its packets. Therefore, it has to drop the packets forwarded from this node. Thus, the solution is that the random back off time of each node is related to its local congestion state, so the congested node has a better chance to win a contention. Moreover, as to drain its buffer faster, this mechanism also allows the child nodes to learn the congestion information indicated by congestion bit in its packet.

According to AL-Rashdan and et al (2010); the technology of intrusion detection is considered one of the common effective approaches or techniques to deal with network security issues and problems. They presented a novel model for intrusion detection purposes. Both NNs and "Support Vector Machine (SVM)" algorithms have

been considered during their investigation. KDD cup 1999 dataset has been employed as a database during both the training and testing phases. Three main phases have been considered during their investigation, which are; clustering, training and finally the detecting phase.

According to mohajerzadeh and Yaghmaee (2010); distinctive and intrinsic characteristics are assigned to WSNs in comparison over the conventional type of network. Several constraints may limit the deployment and improvement of WSNs, such as; the supplying of energy, the capacity of storage and the computational power. The energy constraint is the most critical and essential issue. A routing protocol that is aware of the energy is very significant within WSNs environment; the performance will not be efficient in the case that only energy constraint is considered by this protocol; so the remaining parameters should be also considered in order to obtain efficient performance as much as possible. These parameters are determined depending on the application that the WSNs will be used for; the management of the congestion is one of the most critical issues; since it used, then the packet loss and the consumption of the energy will be reduced.

Furthermore, mohajerzadeh and Yaghmaee (2010) supposed that fairness energy consumption between the node is also essential parameter; since if it does not considered will result in performance degradation due to the network partitioning. They proposed a new protocol recognized as “Tree based Energy and Congestion Aware Routing Protocol (TECARP)” in order to achieve energy efficient routing process within WSNs. The idea of this protocol lies mainly in fairness provision congestion management within the network. Three main stages are considered for this protocol, which are; clustering of the network, routing tree creation and finally forwarding the

data using relay nodes. The hierarchy process of routing has been considered in this protocol. Two main phases are used to perform the routing process, which are; intra cluster and intra clusters. Simulations have been performed in order to ensure the validity of the proposed protocol. The results of the simulation illustrated that TECARP is able to effectively achieve the considered goal.

Johnsson and et al (2009) introduced new SOM variant recognized as "Associative SOM (A-SOM)". This version is similar to the ordinary SOM in addition to including the associative process for at least one external SOM. They dedicated that the expectation modeling is related to A-SOM within one modality because of the invoked activity within other ones. They introduced a generalized algorithm for random associated activities. They also simulate the investigations to evaluate the network performance and its capability for simplifying the new inputs that were not used during the network training phase. The results confirmed the effectiveness and capability of A-SOM to be learnt for the associated representation that is related to the input vectors. Furthermore, the results also confirmed the capability of good generalization.

Misra and et al (2009) proposed the PCCP scheme, which tries to control congestion by reducing packet loss while guaranteeing weighed fairness. Furthermore, it supports the multipath routing with lower control overheads. This scheme composed of three main components; intelligence congestion detection, implicit congestion notification and priority based adjustments. The intelligence congestion detection is based on packet interval time and packet service time. The joint participation of these two factors reflects the current congestion level, therefore providing quality congestion information.

Pang and et al (2008) proposed the “Congestion Control from Sink to Sensors (CONSISE)” mechanism to control the congestion in the direction of sink-to-sensors. There are many factors that cause congestion in this direction, such as; problem of broadcast storm and the traffic on the reverse path. The algorithm of CONSISE operated periodically in the sink and sensor nodes. The nodes identify the forwarding rate and give clear feedback to the nodes that near to the sink. After that, these closer nodes “upstream nodes” modified their forwarding rate conversely. Furthermore, to increase the speed of delivering the packets, the downstream nodes identify the best upstream node to forward the information to it. However, if there is no information has reached to the upstream node as it the most suitable node, then it minimizes its forwarding rate. So, the selected upstream node as the optimal node can then forward data at a higher forwarding rate with no heavy congestion.

Hu and Lee (2008) demonstrated that SOM approach can be classified as NN with two dimensions. The SOM model consists mainly from two layers; network and input layers. The arrangement of the nodes within network layer is performed in an array of type lattice. Several shapes that are Two-dimensional can be used to form this type of arrays. During their work; they have chosen the square as a shape for the lattice array. The cells within network have been associated with weight vectors symbolized as w_1, \dots, w_N , N here is recognized as the cells number. The weight vector elements may be either fuzzy or crisp; during their approach they have based on using crisp type.

The learning process for the network is performed based on using the data samples within input layers. They expanded an approach for the purposes of decentralized localization depending on SOM. The introduced approach was implemented to be compatible with several networks' size. The results for their works

demonstrated the effectiveness for the proposed scheme over the approaches that depend on centralized localizations or individual processor. No anchor nodes were needed within the proposed method. Furthermore; the error investigation demonstrated that sensor network localization can be calculated based on the proposed approach (HU and LEE, 2008).

According to Yun and et al (2007), SOM is considered one of the common techniques that are used for the purposes of data visualization. This approach has been proposed by Kohonen. It can be used in reducing the data's dimension based on employing NN which are self-organized. Regarding to the manner by which the dimensions are reduced when using SOMs, it can be performed by generating map that mainly characterizes with either two or one dimension. The data similarities are plotted via combining the data which are similar to each other. SOMs are effective to be used in the classification for the application that is based on context.

They demonstrated that the complex context classifying and recognition with WSNs has been extensively during the last few years. They demonstrated that the attaining of context classification and recognition automatically seems to be critical and difficult issue. They presented an approach for the purposes of context classification based on Kohonen SOM approach. The result demonstrated this approach is effective to be applied and used within several applications (Yun and et al, 2007).

Akyildiz (2007) suggested the CODA approach, which is another approach to reduce the congestion in the networks and it contains three mechanisms; receiver-based congestion, open-loop, hop-by-hop back pressure and closed- loop multi source multi regulation. It regulates congestion based on the length as well as Wireless Channel node at intermediate nodes. To detect congestion, CODA uses a combination of the present

and past channel loading conditions and the current buffer occupancy at each reliever. It uses a sampling scheme to activate local Channel monitoring. Once detected the node notifies its upstream neighbor node through a back pressure mechanism. The back pressure mechanism operates in an open loop-hop –by hop manner. A node broadcast back pressure messages as long as there is congestion detected. The messages are propagated upstream towards the source

The WSN performance is affected by the congestion, which minimizes the lifetime of the network and increased the amount of lost data. For these two reasons, a scheme of mobile sink that rely on routing was proposed by Khan (2007) to prevent the congestion and to achieve a well-organized routing within the WSN. The in-network storage and sink mobility model has been used in this suggested scheme in order to establish mini-sinks over the sink mobility path. Furthermore, the established mini-sinks operated to gather data from distributed nodes that situated in their neighborhood to prevent the flowing of data into one data gathering point. A large number of nodes were distributed in a random and uniform way.

According to Khan (2007), these nodes sense and report the required readings to be provided into the sink and this occur every fixed interval of time. Moreover, the routing protocol of “Congestion Avoidance Energy Efficient Routing (CAEE)” was presented in this scheme to address the energy efficiency and congestion problems. The traveled data in this scheme have passed through small hops number in order to enhance the consumption amount of energy. The obtained results from the simulation proved that this scheme was very efficient and suitable and it was able to achieve the work objectives. The model of the suggested scheme is shown in Figure 2.5.

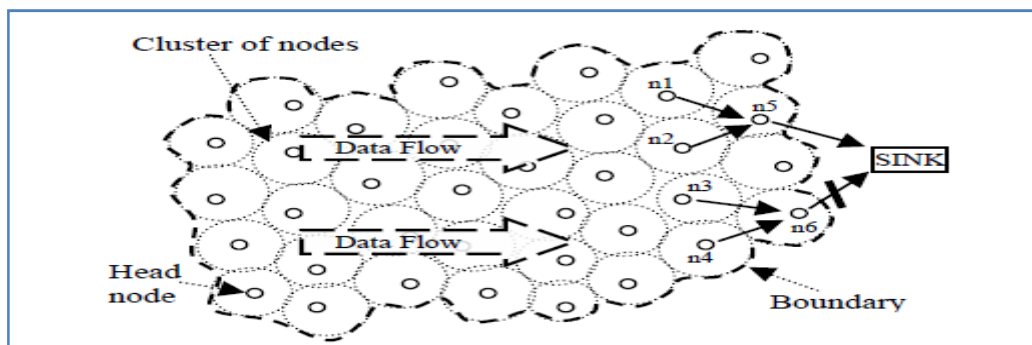

Figure 2. 5: the model of the suggested scheme, (Khan, 2007).

According to Karenos and et al (2007), there are number of flows that passed the routing paths that extended between sensors of data gathering and aggregating sink. Numbers of interferences occurred through these paths which cause arbitrary delays and high loss of packets. Due to this issue, the mechanism of “Congestion Control for Multi-class Traffic (COMUT)” has been suggested to support multi traffic classes. By this scheme, the network is divided into many clusters that proactively and autonomously control the congestion inside the network. The structure of COMUT network involves a large number of sensors that aggregated into clusters. The traveled message composed of intra packets of a sensor update; inter packets of sentinel update and packets of regular data. Furthermore, the sensors inside the cluster report the calculated estimations for the load of traffic periodically. The aggregating cluster and sentinel cluster are used to process the transformed information. After that, the delivered data are then gathered and directed to the sink. The obtained results from simulation proved that;

- The suggested approach was able to attain low delay and high rates of delivery and deal with interfering and multiple flows in an effective way.
- Work properly with primary protocols of routing.
- Provide higher significant flows with higher throughput.

- Save energy.
- Able to deal with failure cases.

Figure 2.6 illustrates the structure of COMUT network.

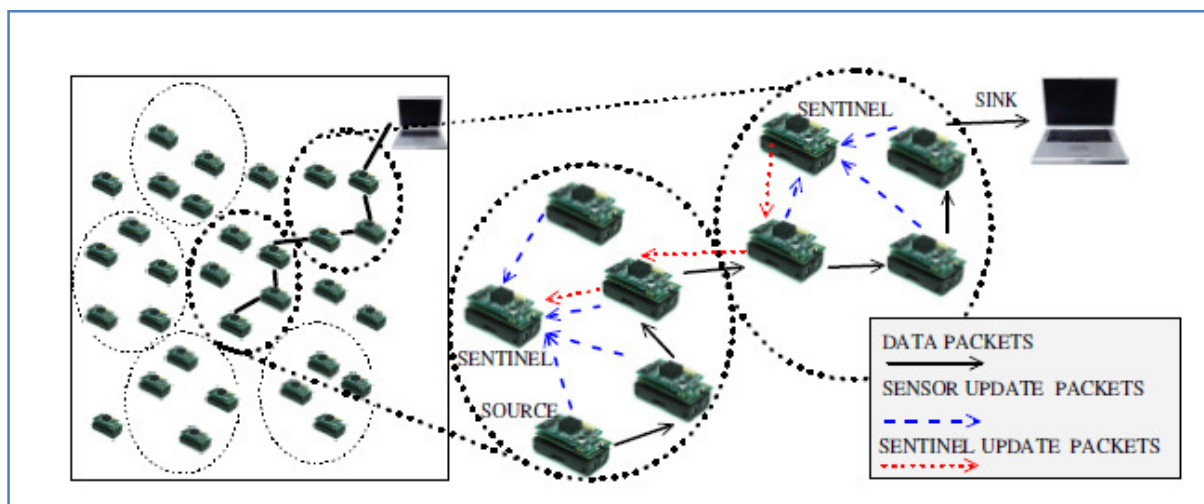

Figure 2. 6: the structure of COMUT network, (Karenos and et al, 2007).

Karenos and et al (2005) suggested the framework of “Congestion Control for Multi-class Traffic (COMUT)” to support the data flows. Distributed and scalable mechanisms that based on clustering were supported by this suggested framework to provide WSNs with multiple traffic classes. In addition, this work aimed to provide the significant flows with high quality service under the congestion process conditions. By this framework, the network has been divided into many clusters that proactively and autonomously control the congestion inside the network scope. So, this enabled the clusters of source sensor to optimally modify their rates based on the varying levels of congestion. The obtained results of simulation proved that this suggested framework was successful in minimizing the number of packet drops and preventing congestion. Also, it helped to enhance and save the energy. This framework can be enhanced in the future by increasing the number of flows.

Lee and et al (2004) demonstrated that energy conversion of sensors in WSNs is considered one of the most common challenges that restricts the process of combining and transferring the data within this type of networks. This will in turns affect the lifetime of these sensors, and so the whole network. The nodes can be connected within clusters intelligently and the data collectively can be also aggregated when using WSNs. They demonstrated that the process of self-clustering distributing is hard challenge to be overcome. They focused on originating of data that are rising from sensors. They introduced a novel approach that is related to collecting data and clustering the nodes.

The main idea within their approach is to make clusters from the nodes depending on the distance that separates them from the sink, after that unsupervised learning approach which is Kohonen "Self Organizing Map (SOM)" will be used to perform the data collection. The result demonstrated that the efficiency in terms of total required energy can be enhanced by approximately 30% when applying their approach. So the whole network lifetime can be expanded (Lee and et al, 2004).

According to Silva (2003), a novel process mentoring approach for employing SOM has been introduced and investigated depending on the target values inclusion on training groups and also based on the rules of learning conversion. A common problem during the SOM training phase is that a large amount of input data may be represented to one of the neuron within the network. This issue occurred due to the randomness in selecting the Kohonen weight values. All the data input may be represented using this neuron with only little information recognized about the input data clusters that are created within Kohonen layer. The conscience mechanism is employed in order to overcome the high frequent of winner neuron. This technique is concerned mainly in

keeping a continuous record about the number of times that each neuron has been specified as winner one. These records are employed latterly in distance measurement biasing during training phase. In case that one neuron has specified as winner one for more than specified average value; it is distance accordingly increased in order to reduce this neuron chance to be selected again as winner one. On the other hand; if there is a neuron that has been rarely selected as winner one; then it is distance accordingly increased in order to increase it is chance to be selected as winner one in the successive times. The proposed approach has been evaluated considering several experiment; the results confirmed it is effectiveness.

Xiao and et al (2003) introduced and investigated the clustering of gene employing both "Particle Swarm Optimization (PSO)" and SOM methods. They dedicated that the techniques of gene clustering is considered significant and important in during the investigation and analysis for the data collection related to the expression of the gene. They defined the gene clustering as the process that is used in combining each set of related genes into one cluster. The levels of gene expression can be measured simultaneously for thousand genes. The dataset should be meaningfully presented using these technologies in order to effectively extract the knowledge from this dataset.

During their implementation; the conscience factor was added to SOM as a way for enhancing the convergence rate. A re-sampling method has been employed in order to measure and evaluate the result robustness. The results confirmed the effectiveness of re-sampling in robustness evaluation for the technique in addition to confirming that a better tradeoff among topographic and quantization error can be achieved.

Ng and Tan (2002) demonstrated that the main purpose behind the usage of classification approach lies mainly in assigning the weight values for the "Contender Network (CN)" that has been previously proposed in the literature. The assigning process is achieved in a decreasing function with respect to the rank. In their works; they tried to introduce a modification for the classification process within CN which is mainly recognized by conscience approach.

They identify this problem by the saturation issue; which mainly occurs and happens in case that the neural network arrives at the saturation level. The count threshold has been introduced in order to address this issue. They have based on several factors in order to specify the threshold, such as; accuracy criteria and network performance rates of confusion and errors. They introduced experiments in order to certain the improvement for the network performance when applying conscience method. The results confirmed the effectiveness of proposed approach.

According to Taner (1997); SOM is simply considered as simulation for the organization procedure that is employed during the information organization within human brain. One neurons layer is included in Kohonen technique and the competitive learning is employed within this layer. Each neuron winning rate is checked for each modification. In case that there is any neuron looks like to be dominant; the conscience technique is used by this neuron and the remaining neurons are given a chance to be included within the learning process. They dedicated that the SOM inputs are firstly normalized; this means that the attributes for all sets should be scaled to specific value. By this procedure; no attribute arbitrary will dominant the clustering procedure. Several inputs connections are assigned to each one of the neurons within WSN. During the training procedure; the neuron that has the closest weights to the input ones is firstly

found and then decelerated as the winner one. The neurons weight are then adjusted and modified. The modification amount is determined based on the distance. The accepted vicinity radius is reduced when the number of iteration increases. The training process is continuously performed until the error between the input and output reaches an acceptable level.

2.3 Summary

It can be concluded that WSNs are widely used in several life practical applications. WSNs may be the next network generation future since it is widely used and employed in several essential and significant fields. This network consists from group of sensors which are sensitive for the environmental phenomenon changes. The sensors may be recognized as the nodes for the networks. This type of networks characterizes with changeable topology for the network due to the sensors or nodes mobility. There is ability to deploy this type of networks within environments in which the ordinary sensors cannot be deployed. It also characterizes with high flexibility due to the dispensing of central sources (Hosseingholizadeh, 2009).

Kohenon SOM is considered common type of NN that is mainly used for the purposes of clustering. It is based on the unsupervised learning approach and it is similar to the neuron connections within human's brain. By employing this approach; the nodes can be grouped in clusters without any need for the data classes. Applying this approach is very effective in conserving the energy and increasing the battery lifetime within WSNs (Mannan, 2012 and Rakocevic, 2013).

3 METHODOLOGY AND SYSTEM IMPLEMENTATION

CHAPTER THREE

3.1 Overview

As mentioned previously, the aim of this thesis is to introduce an approach that can be applied to Wireless Sensor Networks (WSNs) based on SOM NN. This in turn can enhance the efficiency of energy and increasing the lifetime for the whole network. This will be achieved based on using a specific protocol for clustering within WSN. In this thesis; two main criteria will be used in order to achieve effective clustering within WSN; sensor node coordination and level of energy. Due to applying the clustering that is based on energy; the consumption of energy will be balanced when compare it to the case of clusters that have identical energy levels.

3.2 Research Methodology

The methodology that will be followed within this thesis is mainly divided into three main stages as illustrated below in Figure 3.1.

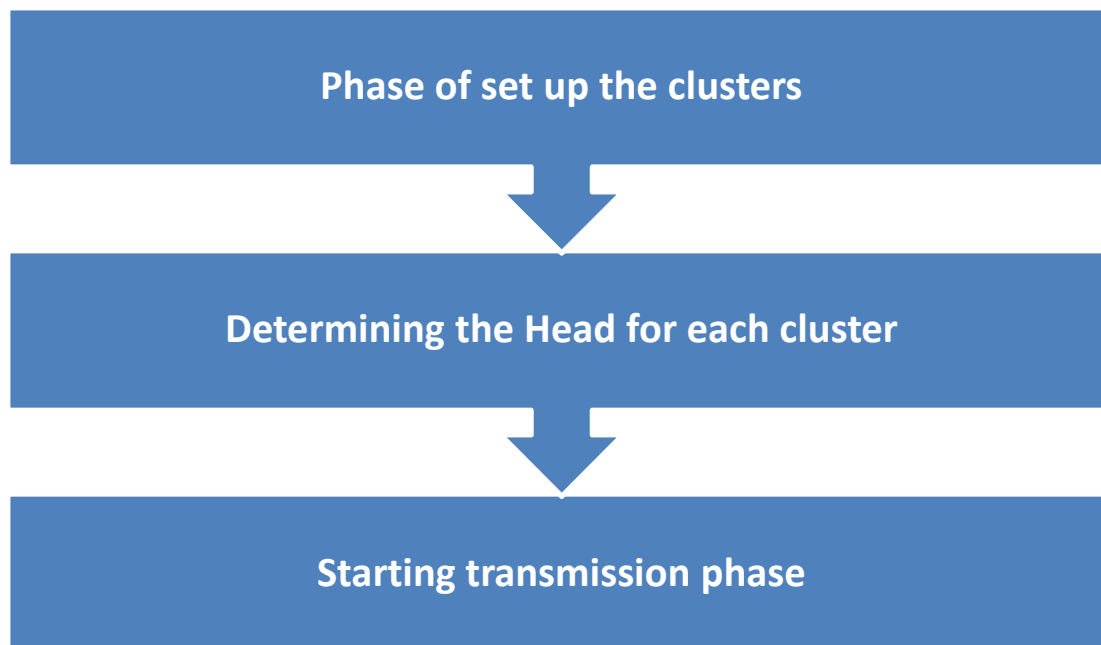

Figure 3. 1: Main stages for the proposed scheme.

As shown in Figure 3.1, the stages that will be subsequently followed in this thesis are: set up phase, specifying the cluster heads and finally initiate the transmission

phase for the data between nodes and BSs. Based on applying those stages; the nodes will be prevent from either early or random death as much as possible, which in turns leads for maximizing the lifetime of whole network.

In this thesis, different scenarios will be applied in order to increase lifetime and decrease energy consumption.

3.3 Proposed Algorithm

3.3.1 Setting up the Clusters stage

The proposed scheme is initiated by the clusters' setting up. This clustering will be performed via applying SOM approach. The node level of energy in addition to x and y coordinates will be considered as the SOM input vectors. As a result, a matrix that has dimension of $n \times 3$ can be formed; this matrix will be named as D . because of applying different variable types; then these values must be normalized. The normalization process will be achieved via applying the approach of normalization that is recognized as Min-Max approach based on (Enami et al, 2013); for element a ; the maximum and minimum value are symbolized as \max_a and \min_a . A value v can be mapped between (0, 1) via using equation 1 below;

$$V = \frac{v - \min_a}{(\max_a - \min_a)} \quad (1)$$

Based on equation 1, the matrix of the data samples D with size $(n \times 3)$ can be given as illustrated below in equation 2;

$$D = \begin{bmatrix} \frac{xd_1}{xd_{max}} & \frac{yd_1}{yd_{max}} & \frac{E_1}{E_{max}} \\ \vdots & \vdots & \vdots \\ \frac{xd_n}{xd_{max}} & \frac{yd_n}{yd_{max}} & \frac{E_n}{E_{max}} \end{bmatrix} \quad (2)$$

Where:

D represents the SOM input vectors

$E = E_1, \dots, E_n$: represents the nodes' levels of energy

$XD = xd_1, \dots, xd_n$: represents the X coordinates.

$YD = yd_1, \dots, yd_n$: represents the Y coordinates.

xd_{max} : represents the X coordinate maximum value within network space.

yd_{max} : represents the Y coordinate maximum value within network space.

E_{max} : represents the energy that remains from the maximum node energy. When the algorithm begins; this value is symbolized as $E_{initial}$.

Now, regarding to the weight matrix, it will be determined by BS via selecting m nodes which characterizes with the maximum energy level; the selected nodes have identical values for the level of energy. The network space is able now be divided into several m regions, the node which are the nearest to the center will be latterly selected. Large value of m is required to be considered with WSNs because of applying two SOM stages. The m nodes here can be selected in a random way. So; the weight matrix for the three variables (i.e. size of $3 \times m$) can be written as given in equation 3 below;

$$W = \begin{bmatrix} \frac{xd_1}{xd_{max}} & \dots & \frac{xd_m}{xd_{max}} \\ \frac{yd_1}{yd_{max}} & \dots & \frac{yd_m}{yd_{max}} \\ 1 - \frac{E_1}{E_{max}} & \dots & 1 - \frac{E_m}{E_{max}} \end{bmatrix} \quad (3)$$

Where W represents the SOM weight matrix

As shown in equation (3), the number of rows within the weight matrix is exactly the number of considered variables in D matrix, which are the node level of energy in addition to x and y coordinates. The number of columns depends is equal to the

number of selected nodes. The normalization process is performed for each row independently and differently from other rows based on what the row represent. For more explanation; the X coordinates row is normalized using the largest X coordinate within network space. Y coordinates row is normalized using the largest y coordinate within the network space; the same process is also applied for nodes energy row with normalization performed using E_{\max} .

$1 - \frac{E_1}{E_{\max}}, \dots, 1 - \frac{E_m}{E_{\max}}$: is recognized as the M selected nodes consumed energy. The

Figure 3.2 demonstrates the topology structure of SOM within WSNs. It now clear that all elements within weight matrix are always less than 1; due to normalization process, and hence $1 - \frac{E_m}{E_{\max}}$ is less than 1 but also greater than 0.

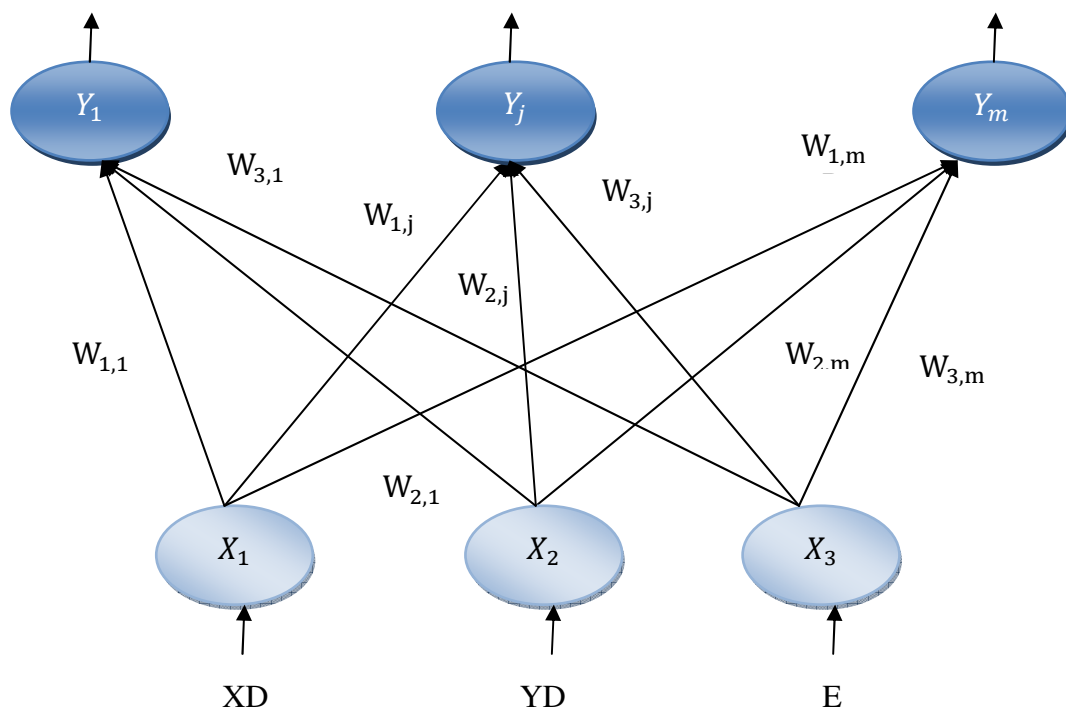

Figure 3. 2: Topology structure of SOM for the proposed scheme.

Regarding to the learning process within WSN; then it is performed based on Euclidian distance minimization among map prototype that has been given weight depending on h_{ij} or the topology Gaussian function and the input samples. As a result

of this learning process; criterion must be reduced as much as possible, this criterion is illustrated below in equation 4 below.

$$E_{SOM} = \frac{1}{N} \sum_{k=1}^N \sum_{j=1}^M h_{j,N(X^{(k)})} \|W_j - X^{(k)}\|^2 \quad (4)$$

$$h_{i,j}(t) = \exp\left(-\frac{\|r_j - r_i\|^2}{2\sigma_t^2}\right) \quad (5)$$

$$\sigma(t) = \sigma_0 \exp(-t/T) \quad (6)$$

In the above equation, M represents the number of units that have been used for mapping, $N(X^{(k)})$ represents neuron which that owns the closest exhortation related to sample of data, h represents the function of Gaussian neighborhood, J represents the map unit, i represents input sample, $\|r_j - r_i\|^2$ represents the distance that separates input sample and map unit, σ_t represents radius of neighborhood that has been taken at t time, t represents the iteration number that are used in order to learn the network, and T represents the maximum iteration number during training process it can be considered as length of training. Distance which separates the map neurons and vector of mapping is also calculated here. The competition phase winner is the neuron that characterizes with minimum distance regarding to X_k input sample as illustrated below in equation 7 below;

$$N(X_k) = \arg_{1 < j \leq m} \min \|W_j - X_k\|^2 \quad (7)$$

The argument within the above equation is used to make a decision and select the neuron that has the minimum distance value with X_k input sample. This decision is performed after calculating all neurons corresponding distances with X_k , and then returning the neuron with the minimum distance value as the winner of the competition

stage. When the learning process initiated; σ_t characterizes with large value. While the algorithm time is increased then this radius will be reduced. When the competition phase is finished; the winner's weight vector is updated using SOM. The update process also includes the winner vector neighbours which are located on $R(N(X_K))$ neighborhood radius. Now;

$$W_{j(t+1)} = \begin{cases} W_{j(t)} + \alpha(t)h_{j,N(x_k)}(t)_k (x(t) - W_{j(t)}); & \text{when } W_j \in R^{N(x_i)} \\ W_{j(t)} & ; \quad \text{otherwise} \end{cases} \quad (8)$$

$h_{j,N(x_k)}$ represents the neighbourhood function that taken at t time, and $\alpha(t)$ represents the linear factor of learning which can be calculated as given below in equation 9;

$$\alpha(t) = \alpha_0(1 - t/T) \quad (9)$$

The initial rate of learning is symbolized by α_0 . Iteration number is symbolized by t and again T is training length. The learning process is continuously performed until no change is probable to occur within the weight vectors between sensor nodes.

3.3.2 Determining the CH

Several approaches have been applied in the literature in order to effectively select the head for each cluster. Dehni and et al (2005) used three main criteria in order to select the Cluster Heads (CHs), which are: sensors which characterized with maximum value for energy level, sensors which have shortest distance to centroid and finally sensors which have shortest distance to BS. CH can be obtained using different methods

- 1) The sensor having the maximum energy level
- 2) The nearest sensor to the BS

3) The nearest sensor to gravity center (centroid) of the cluster.

When the nearest node to BS in a cluster is selected as CH, it must be ensured that it will consume least energy to transmit the messages to BS. Also the nearest sensor to gravity center (centroid) of the cluster insures least average energy consumption.

In this work, CH is the nearest sensor to gravity centre (centroid) using localization method, by finding position to nodes and chooses min. distance to centroid, using beacon node and unknown node.

3.3.3 Transmission Stage

The final stage within the proposed algorithm is the phase of transmission. This stage is initiated after performing the cluster forming and setting up in addition to determine the CH within each one of these clusters. At this time; the CH start gathering the received sensed data from these nodes and then transfer them again to the BS. During this phase; the energy that has been consumed by the nodes within WSNs is calculated. The following two equations demonstrate the amount of energy needed to perform transmission process for k bits accross distance d (Abrishambaf and et al, 2011)

$$E_{TX}(k,d) = K \cdot E_{elec}(k,d) + K \cdot \varepsilon_{friss} d^2 \quad (10)$$

On the other hand; the needed energy during receiving process for k bits and d distance can be calculated from equation 11 below; (Abrishambaf and et al, 2011)

$$E_{RX}(k,d) = E_{RX_ele}(k) = K \cdot E_{elec} \quad (11)$$

E_{elec} represents the needed energy for the electronic reception and transmission, d is the distance that separates the transmitter from the receiver and k is the message size measured in bits, E_{Tx-amp} represents the energy needed for amplification, and ϵ_{friss} represents the factor of amplification and threshold distance is symbolized by $d_{crossover}$, where factors of transmission are altered at this distance.

When the phase of transmission finished, a novel round will be counted and the CH node will be adjusted. In case that a reduction occurred within the nodes level of energy; then the re-clustering process could be performed. So, the level of energy within those m nodes which have the largest values of energy within clusters will be periodically tested. As a result; the proposed algorithm for SOM method is enhanced by adding epsilon ($\epsilon = 10^{-6}$) value that control current weights and previous weight values to insure that NN work in convergence mood as shown below

IF
 $|W^{NEW} - W^{OLD}| < \epsilon$
CONTINUE
ELSE GO TO COMPUTE WINNER FINDING

The above process can be illustrated using MATLAB to ensure stability in NN, by compute mean square error (MSE) over the network as shown in Figure 3.3

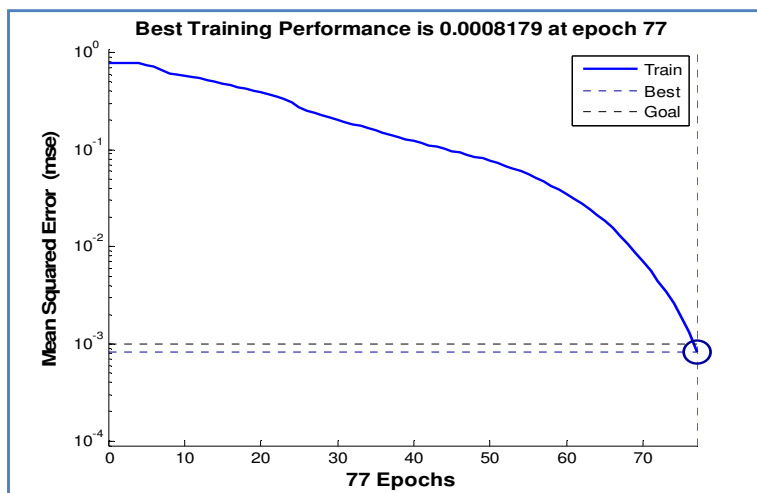

Figure 3. 3: MSE in NN

The overall steps for enhanced SOM can be summarized as given below;

- ✚ Initialization: at this stage; the sensor nodes having the same levels of energy are used within particular area.
- ✚ Setting up clusters based on SOM and determining the CH during the current round in addition to calculate the weights of WSNs. This can be done using
 - ✓ **Initialization:** choose random values for initial weights $w_j(0)$.
 - ✓ **Winner finding:** find winning node j at time t using min Euclidean distance.
 - ✓ **Weights Update:** adjust weights of winner and its neighbors.
 - ✓ **Check** that updated weight and previous weight within the suggested eps.
- ✚ The data transmission stage; at which the nodes send their sensed data to the CH and the CH is gathering the packets from all nodes to be transferred lately to BS. During this stage, the needed energy for both transmission and reception process is calculated in addition to the energy consumed by CG during aggregation of data. The CH is also adjusted after each phase of transmission using nearest sensor to gravity center (centroid) using localization method

The block diagram that summarizes all above equations and details is illustrated below in the following Figure 3.4;

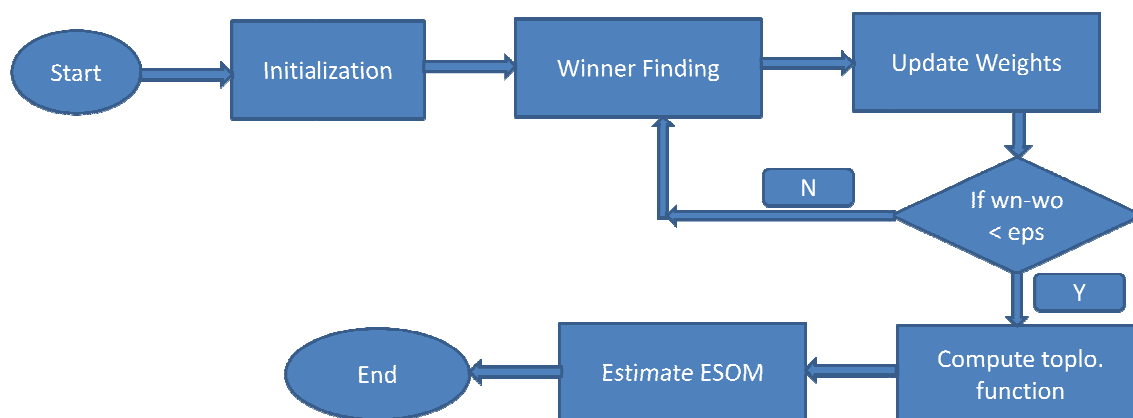

Figure 3. 4: Flowchart of SOM in WSNs

3.4 Suggested Scenarios

The general goal from this thesis is try to find the most appropriate solution that will be effectively applied within WSNs and achieve the best performance in terms of energy consumption and lifetime of the nodes and so the whole network. There are several proposed scenarios that can be applied in order to perform the clustering process in addition to the selection of CH to effectively start the transmission process of data between nodes and BS. This section will introduce some of the suggested scenarios that can be applied to achieve the thesis goal, when all possible scenarios discussed in details; the most appropriate one will be selected.

3.4.1 Clustering of WSNs Using Kohonen SOM

Now, the performance of the proposed SOM will be tried to be improved by using Kohonen algorithm. This validity for this scenario will be discussed and investigated latterly in within next chapter; in order to ensure it is ability to enhance the WSN performance in terms of different criteria in comparison with the ordinary SOM.

In this thesis; an additional criterion will be added which is the frequency of CH. The frequency here is recognized as the number of times for which the sensor node was previously determined as CH. The above mentioned criteria have been deployed together in order to form the optimal cost function for the nodes within WSNs; this function is demonstrated in equation 12 below;

$$\begin{aligned} cost(i) = & \alpha \left(\frac{E_o - E_i}{E_o} \right) + \beta \left(\frac{DtoBS_i - DtoBS_{min}}{DtoBS_{max} - DtoBS_{min}} \right) + \lambda \left(\frac{DtoC_i - DtoC_{min}}{DtoC_{max} - DtoC_{min}} \right) \\ & + \omega \left(\frac{CHfreq_i - CHfreq_{min}}{CHfreq_{max} - CHfreq_{min}} \right) \quad (12) \quad (Rathi et al, 2014) \end{aligned}$$

In the above equation;

E_o is defined as the nodes initial energy.

E_i is defined as the i^{th} node remaining energy.

$DtoBS_i$ is defined as the distance that separates BS from i^{th} node.

$DtoBS_{max}$ is defined as the distance that separates the BS from the farthest node within the cluster.

$DtoBS_{min}$ is defined as the distance that separates the BS from the nearest node within the cluster.

$DtoC_i$ is defined as the distance that separates node I from the cluster's centroids.

$DtoC_{max}$ is defined as the distance that separates cluster's centroids from farthest node within that cluster.

$DtoC_{min}$ is defined as the distance that separates cluster's centroids from nearest node within that cluster.

$CHfreq_i$ is defined as the times for which the node was determined CH.

$CHfreq_{max}$ is defined as maximum value for which the node was specified as CH within the concerned cluster.

$CHfreq_{min}$ is defined as minimum value for which the node was specified as CH within the concerned cluster.

α, β, λ and ω are determined experimentally and all of them have a sum equals to 1. These factors have been determined based on method of "Analytic Hierarchy Process (AHP)". By this approach; the weights are resulted from the pair-wise

comparison transformation. Based on this approach, the weight and related factors are given as shown below.

$$w^t = [0.5619, 0.0774, 0.0460, 0.3150]$$

$$\alpha = 0.562, \beta = 0.077, \lambda = 0.046 \text{ and } \omega = 0.315$$

AHP is considered one of the most common approaches that are employed for the purposes of making decisions based on several criteria.

During current round; the CH will be assigned to the node that has minimum value for cost function. This CH will be adjusted after each phase of transmission. A different node will be selected each time. When the process of CH selection finished; the BS broadcast message that contains the CH ID to the nodes within cluster.

Kohenon method will be achieved based on Aslam et al (2011) via firstly suppose set of assumptions within WSNs as follow;

- ✚ The distribution of nodes within WSNs is random within 2D space.
- ✚ All sensors within WSN recognize the BS location.
- ✚ No restrictions are assumed to be put for the BS computation capabilities in addition to give BS improved communication which in turns qualified it to be dominant node.
- ✚ Now, regarding to the transmission decision for the nodes, all nodes within the WSNs are able to can perform the transmission process using different changeable levels of power. This level will be selected based on the distance that separates the nodes from the BS.
- ✚ The sensor nodes are supposed to be able to evaluate the distance approximately depending on the strength for the received signal. The level of transmitted power should be known and no fading is assumed to be occurred due to the transmission channel between sensor nodes.

- ✚ Regarding to the operation model of network; then it is assumed to be round. The round starts with phase of clustering and then it followed by the phase of data collection from the sensor nodes.
- ✚ It is also assumed here that each one of the sensor nodes between both active and sleep modes. Based on these assumptions; the consumed energy amount for message of k bits over d distance among nodes can be illustrated as given below in equation 13 below.

$$E_{Tx} = \begin{cases} k \cdot E_{Elect} + k \cdot \varepsilon_{friss} \cdot d^2 & ; \text{ when } 0 < d < d_{crossover} \\ k \cdot E_{Elect} + k \cdot \varepsilon_{mp} \cdot d^4 & ; \text{ when } d > d_{crossover} \end{cases} \quad (13) \text{ Aslam et al (2011)}$$

E_{Elect} : the consumed energy amount within electronics. ε_{friss} is recognized as the consumed energy amount within amplifier in case the transmission is performed at $d < d_{crossover}$. ε_{mp} : is recognized as the consumed energy amount within amplifier in case the transmission is performed at $d > d_{crossover}$.

Now regarding to the phase of CH selection; it is very critical issue as mentioned previously since that the selection process gives an indication about the amount of consumed energy within WSNs. When selecting CH; it must be ensured that this CH will cover the related cluster uniformly and effectively. CH is chosen based on AHP method when cost function stop at certain threshold called growth threshold (GT). GT based on the typical area in the problem, once the cost function at iteration 'i' reached GT, The node which has the minimum cost will be selected as the cluster head of current round. Certainly after each data transmission phase, the next cluster head will be a different node (cluster head rotation). After determining cluster head nodes, BS assign appropriate roles to all nodes by sending messages containing related cluster head ID

Figure 3.5 summarizes all considered equation and details.

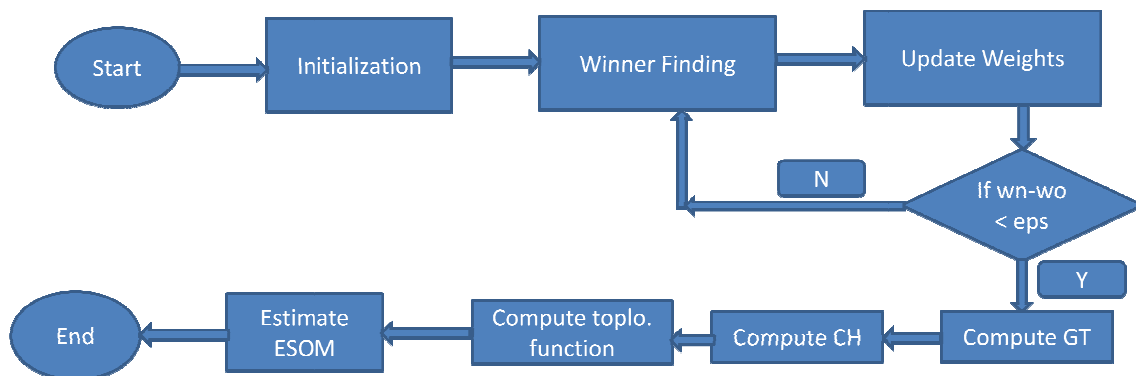

Figure 3. 5: Flowchart of KSOM in WSNs

3.4.2 Clustering of WSNs using Kohonen SOM with Conscience Function

As mentioned previously; a normalization process must be performed to the SOM inputs. This normalization is very effective and significant in order to prevent the attributes to individually dominant and control the whole cluster. The training process for the NN is performed via finding the winner neuron as previously mentioned. After that, the neurons weights will be varied in inverse relation to the distance d . The neighborhood radius will be latterly decreased while increasing the iteration number.

If this process is performed using N attributes; equation 14 below can be used in order to calculate net inputs based on *Turhan* (1997).

$$net_k = \sum_{i=1}^N [x(i) \cdot w(i, k)] \quad (14)$$

k : k^{th} neuron.

N : number of used attributes.

$x(i), w(i)$: direction of unit vectors.

$w(i, k)$: the corresponding weight vector of neurons .

The second approach will be applied in order to compute how much the two vectors are similar to each other. This will be used in calculating Euclidean distance that was introduced in the previous sections as demonstrated below in equation 15;

$$net_k = \sqrt{\sum_{i=1}^N [x(i) - w(i, k)]^2} \quad (15)$$

When net is equals to zero then the two vectors are determined as identical ones. On the other hand, the vectors are assumed to be within opposite directions in case that the net is equals approximately twice normalized value for one of them. The winner node is selected to be the node that characterizes with minimum value for the Euclidean distance. The conscience approach will be deployed here in order to prevent the nodes exceeding the limits for being selected as winner one. Now, assume the output for the neuron number i is given by equation 16 below based on Melody Y. Kiang (2001);

$$y_i = \begin{cases} 1; & \|w_i - X\|^2 < \|w_j - X\|^2 \\ 0 & ; elsewhere \end{cases} ; i \neq j \quad (16)$$

Depending on the number of times that node selected as winner node, a bias can be developed. This bias p is continuously adjusted based on equation 17 below.

$$p_i^{new} = p_i^{old} + \beta [y_i - p_i^{old}] \quad (17)$$

β Here is a factor that must be selected within the range $0 < \beta \ll 1$; it is here assumed to be equals to 0.0001. Based on this; equation 18 below can be deployed to attain conscience factor or parameter as follow.

$$b_i = C \left(\frac{1}{N} - p_i \right) \quad (18)$$

The final stage will be the update for both the winning sensor nodes weights using equation 19 below;

$$w_{(n+1)}(k, j) = w_n(k, j) + \eta(n)[x(j) - w_n(k, j)] \quad (19)$$

K is the node that wins the competition, j is the attribute number. $\eta(n)$ is defined as modification. Figure 3.6 summarizes the main stages for KSOM with conscience function of NNs.

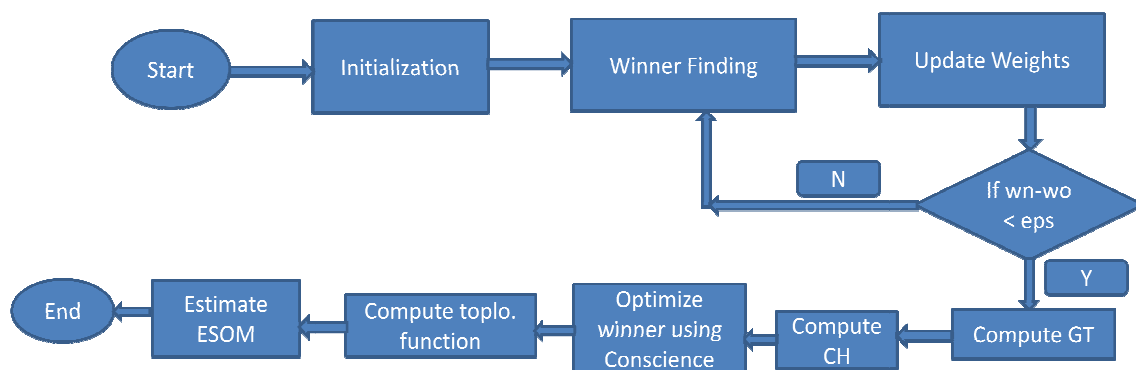

Figure 3. 6: Flowchart of KSOM with Conscience function

3.5 Neural Network in WSN

There are many different types of Artificial Neural Networks, but they all have nearly the same components, Processing Unit, Combination Unit, and Transferring Unit

Each unit performs a relatively simple job: receive input from neighbors or external sources and use this to compute an output signal which is propagated to other units. Apart from this processing, a second task is the adjustment of the weights. The system is inherently parallel in the sense that many units can carry out their computations at the same time. Within neural systems three types of layers can be distinguished:

- 1) Input Layer which receives data from outside the ANN.
- 2) Output Layer which send data out of the neural network.
- 3) Hidden Layer whose input and output signals remain within the neural network.

An important property of neural networks is their ability to learn from input data with or without a teacher. Learning is one of the central issues in our research as it is for other researchers developing neural networks. Learning is a process by which the free parameters of a neural network are adapted through a process of stimulation by the environment in which the network is embedded. The type of learning in neural networks is determined by the manner in which the parameter changes. It can happen with or without a teacher. In unsupervised or self-organized learning, the network is not given any external indication as to what the correct responses should be nor whether the generated responses are right or wrong, It is based upon only local information.

In WSN, NN can be used in clustering to provide best coverage over the typical area, since the input of neural network are random sensors and the output the sensors within clusters, Figure 3.7 illustrates the relation between WSN and NN.

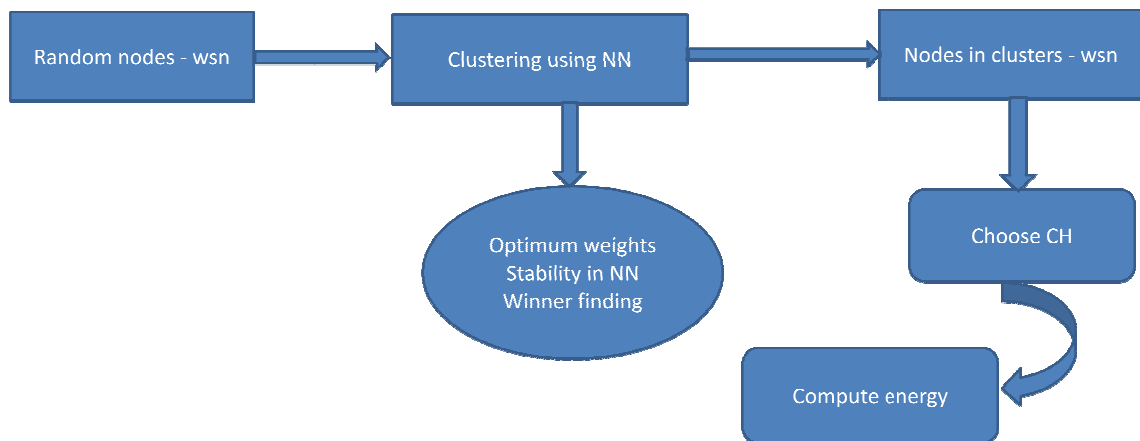

Figure 3. 7:Relation between NN and WSN

4 RESULTS AND DISCUSSION

CHAPTER FOUR

4.1 Overview

The WSNs performance in terms of average energy and average lifetime has been studied through developing a MATLAB code that simulates all previous equations in details. The code will be divided into main stages; the first stage evaluates and compares the performance of WSNs for SOM and KSOM algorithms. In the second stage, the first part will be developed in order to study and evaluate the effect of adding the conscience function of the neural network to the system and compare it with the first stage. During the two stages; the average lifetime and average consumed energy will be used as performance criteria. Three main cases will be considered and investigated during the evaluation, which are Kohenon, KSOM and KSOM with conscience function of NNs.

4.2 First Part: Results for SOM and KSOM algorithms

A 700m*700m area has been assumed for the WSN, as a case study, by choosing small area the performance of the results get better, vice versa by choosing large area. The positions for the users' sensors are then applied within this selected area. Each node has a fixed Omni direction transmission; all nodes have identical transmission range. It is suggested that area is 700m*700m, since clustering area will be divided on specific typical area.

An example for the obtained users' locations is illustrated below in Figure 4.1. As shown in Figure 4.1, the nodes are randomly distrusted over the area while clustering for sensors will be presented to group them in best form.

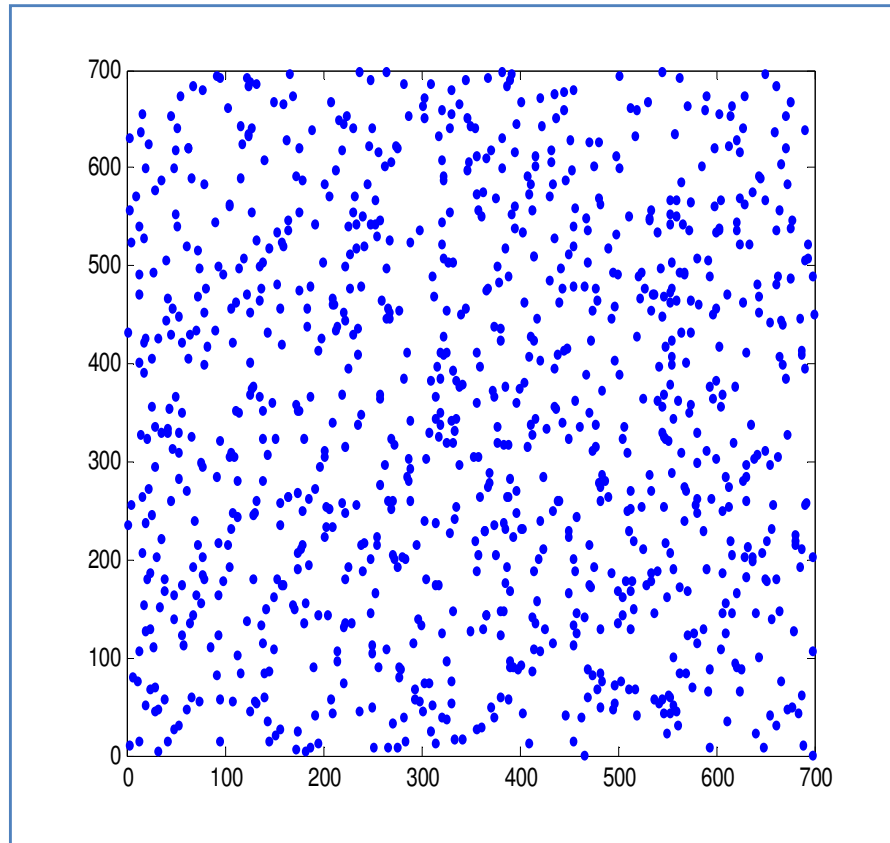

Figure 4. 1: Simulation scenario

As shown in Figure 4.1; the sensors which are represented in bold blue points are randomly distributed with available WSN area. The nodes start exchanging and routing data between each other and among BS. The distance from the sensor to the sink is also calculated and the energy for this sensor is continuously updated.

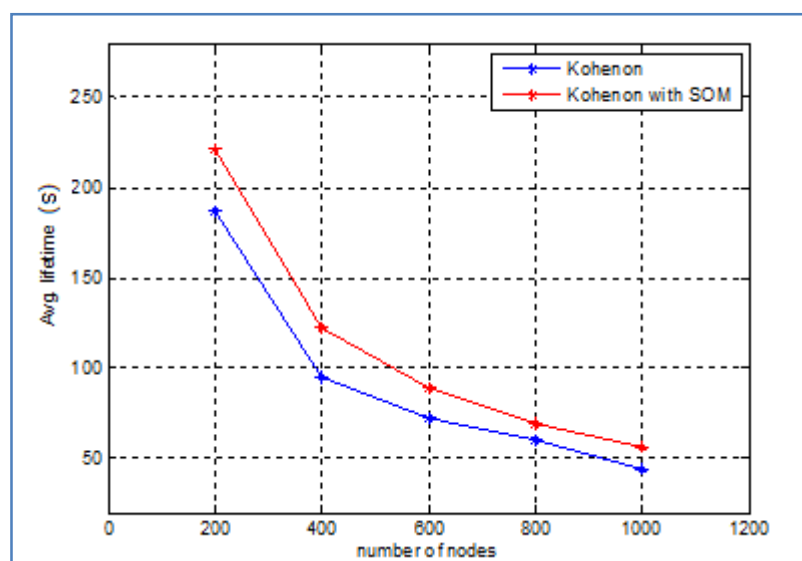

Figure 4. 2: Average lifetime for both kohenon and KSOM algorithms

As illustrated in Figure 4.2, the average lifetime is clearly enhanced due to applying KSOM in comparison with SOM algorithm. It can be clearly noticed that the average lifetime of the WSN decreased dramatically when the number of nodes within WSN increased. The maximum lifetime occurred at 200 nodes with value of approximately 225 rounds, this value obtained with KSOM algorithm, while the minimum lifetime occurred with for 1000 nodes with value of approximately 55s. For Kohonen algorithm; the lifetime is varied between 190s and 40s with 200 and 1000 nodes respectively.

As illustrated in Figure 4.2; the performance of KSOM is preferable to Kohonen algorithm since KSOM has always larger value for the network lifetime. The performance between both algorithms in terms of lifetime value at 200 nodes can be calculated as given below;

$$performance = \left| \frac{KSOM_{life\ time} - Kohonen_{life\ time}}{KSOM_{life\ time}} \right| = \left| \frac{255 - 190}{255} \right| = 25.4\%$$

An enhancement of 25.4% is achieved when applying KSOM over Kohonen algorithm; so it is clearly that KSOM outperforms Kohonen algorithm.

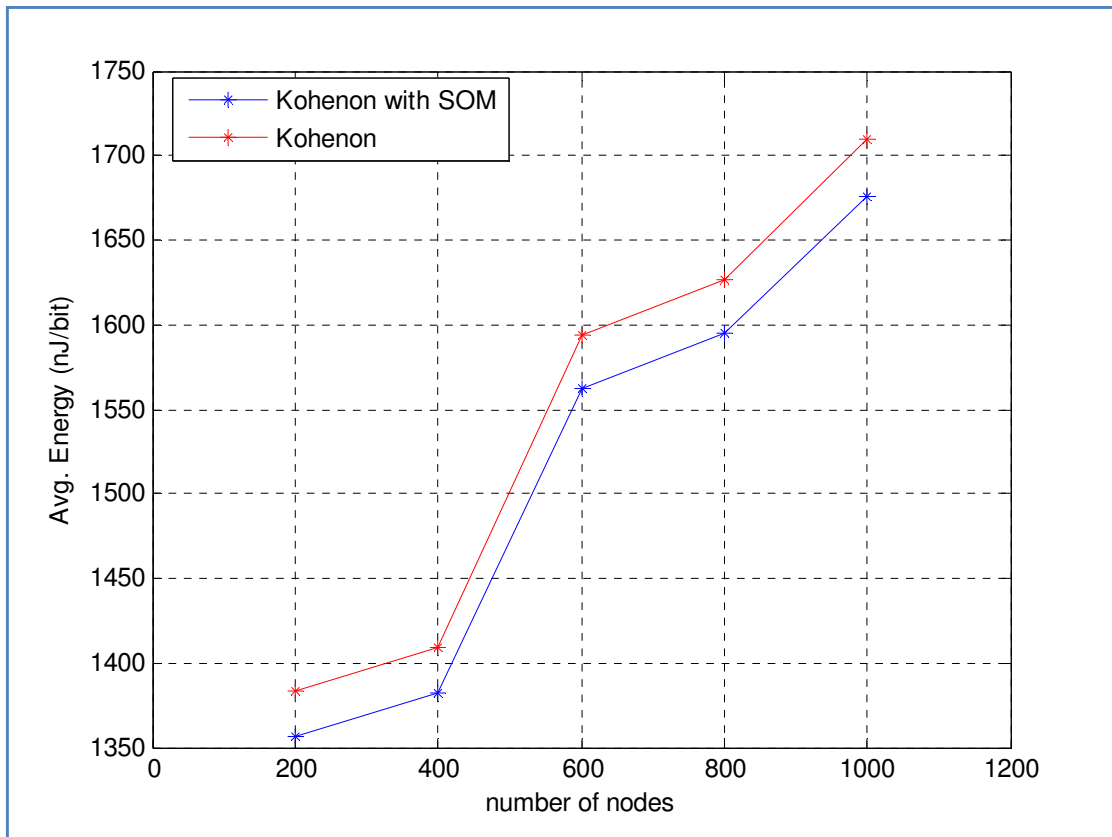

Figure 4. 3: Average energy for both Kohenon and KSOM algorithms.

Another criterion has been selected to evaluate the performance of the proposed methods, which is the average consumed energy. It can be noticed that the use of Kohenon with KSOM algorithm outperforms the use of Kohenon algorithm only. The average energy for KSOM is varied between 1355nJ J and 1670nJ J with 200 nodes and 1000 nodes respectively. On the other hand; the average energy for Kohenon algorithm is varied between 1380nJ and 1710nJ with 200 nodes and 1000 nodes respectively.

As illustrated in Figure 4.3, the performance of KSOM is preferable to Kohenon algorithm since KSOM has always larger value for the network lifetime. The performance between both algorithms in terms of energy consumption value at 200 nodes can be calculated as given below;

$$\text{performance} = \left| \frac{\text{KSOM}_{\text{energy}} - \text{Kohenon}_{\text{energy}}}{\text{KSOM}_{\text{energy}}} \right| = \left| \frac{1355 - 1380}{1355} \right| = 1.845\%$$

4.3 Second Part: Performance of WSNs with Conscience Function

Three cases were considered during the implementation, which are; Kohenon, KSOM and KSOM with conscience function of neural network. The network performance was evaluated using two main criteria, which are; the average lifetime and the average energy. The obtained results are now analyzed. The first obtained result is the average lifetime for the WSN as illustrated below in the following Figure.

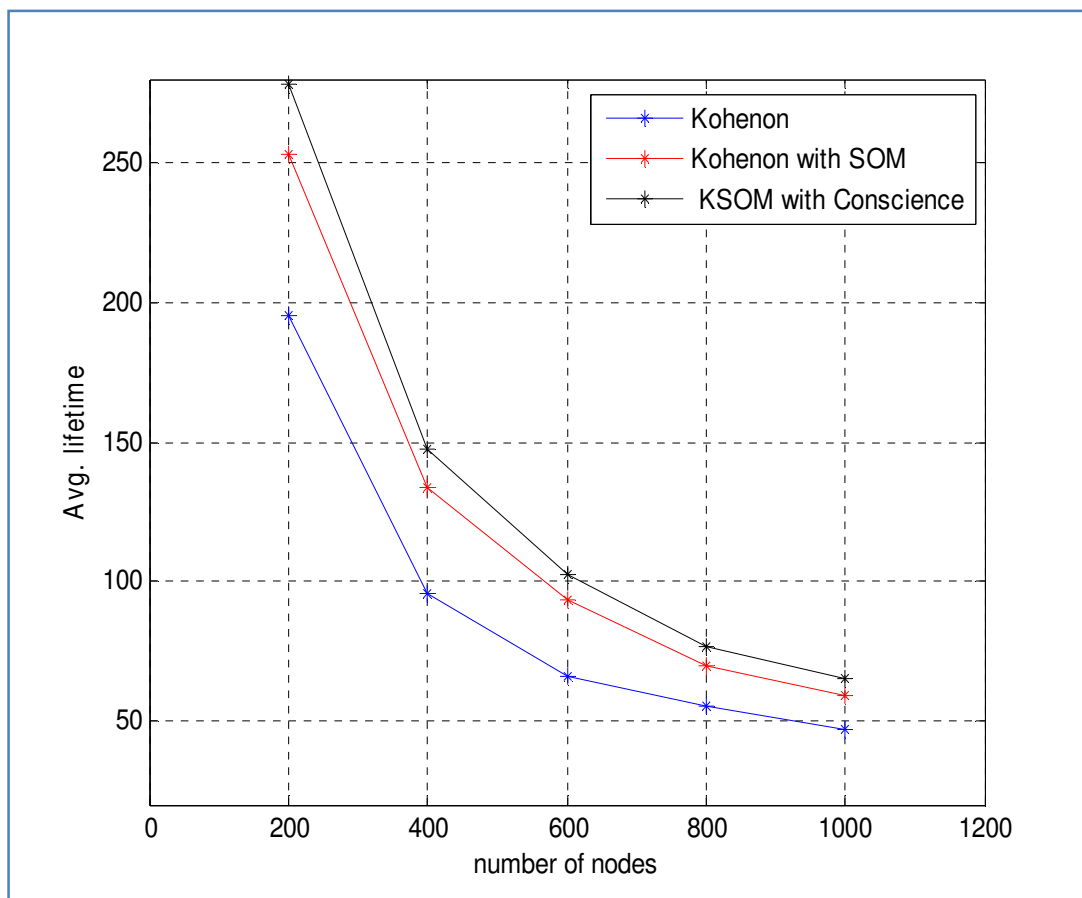

Figure 4. 4: The average lifetime for the WSN considering several numbers of nodes.

Figure 4.4 illustrated the average lifetime for the WSN considering several number of nodes for Kohenon, KSOM and KSOM with conscience function of neural network. As shown above all curves have an inverse relationship with nodes number; so the average lifetime of the network decreases when the number of the nodes increases. For Kohenon case, the average lifetime is varied between 195 s and 45s for 200 nodes and 1000 nodes respectively, while it varied between 250 s and 65s for the same range for KSOM. Finally, for KSOM with conscience function; it can be easily noticed that this curve outperforms the two other curves; the lifetime is varied between 275s and 70 s

for 200 nodes and 1000 nodes respectively. Figure 4.5 summarizes the average lifetime for the three cases considering several number of nodes each time.

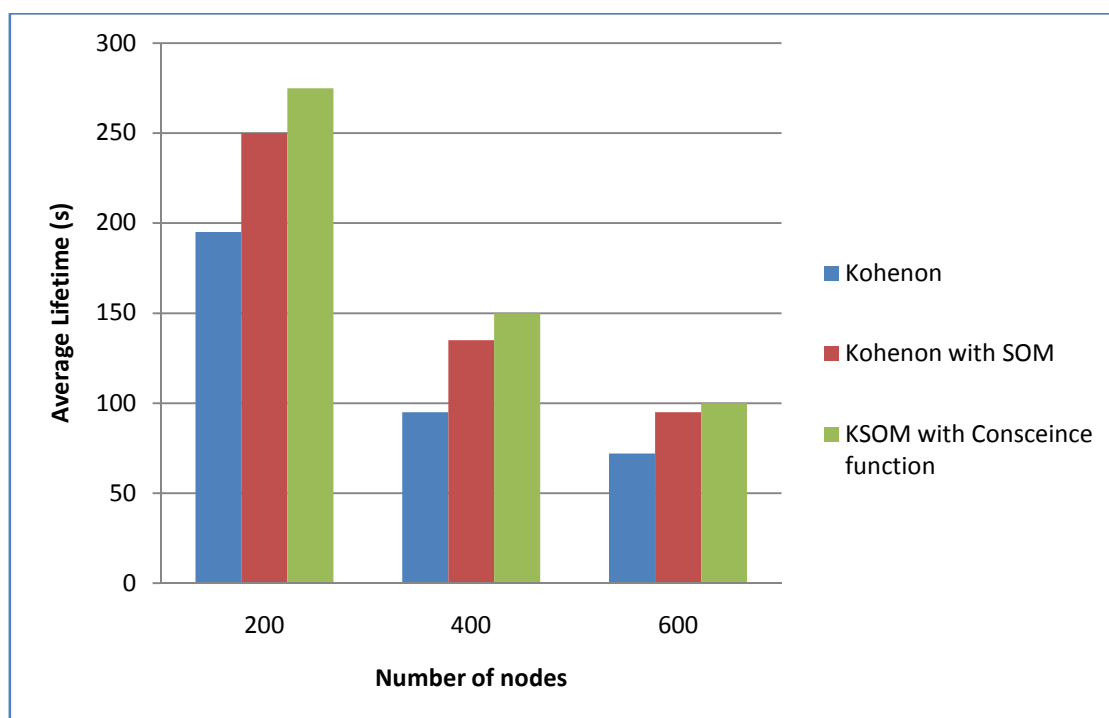

Figure 4. 5: Average lifetime considering several nodes number.

The performance of KSOM is preferable to Kohenon algorithm since KSOM has always larger value for the network lifetime. The error between both algorithms in terms of lifetime value at 200 nodes can be calculated as given below.

$$performance = \left| \frac{KSOM_{life\ time} - Kohenon_{life\ time}}{KSOM_{life\ time}} \right| = \left| \frac{130 - 90}{130} \right| = 30.7\%$$

An enhancement of 24% is achieved when applying KSOM over Kohenon algorithm; so it is clearly that KSOM outperforms Kohenon algorithm.

The enhancement for the average lifetime due to applying KSOM with conscience function of neural network over KSOM can be calculated as given below considering 200 nodes.

$$performance = \left| \frac{KSOM\ with\ conscience\ lifetime - KSOM_{lifetime}}{KSOM\ with\ conscience\ lifetime} \right| = \left| \frac{150 - 130}{150} \right| = 13.33\%$$

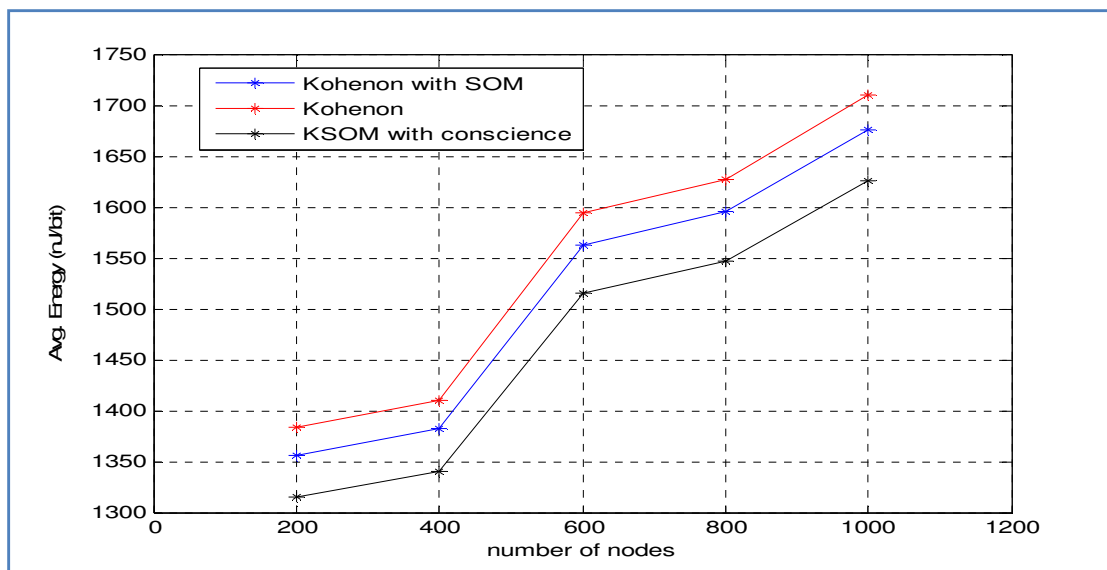

Figure 4. 6: Average energy for Kohenon, KSOM and KSOM with Conscience function.

The second criterion that is used for the WSN performance evaluation is the average energy. Figure 4.6 demonstrates the WSN performance in terms of this criterion for the three considered cases. The average energy is directly proportional to the number of the nodes; so when the number of nodes increases then the average energy also increased. Again; KSOM performance is better than Kohenon algorithm. Furthermore; adding the Conscience function to KSOM makes the WSN enhances performance in comparison with Kohenon and KSOM algorithms. The average energy in case of applying conscience function is varied between **1320 nJ/bit** and **1625 nJ/bit** for 200 nodes and 1000 nodes respectively. While it varied between **1360 nJ/bit** and **1675 nJ/bit** for 200 nodes and 1000 nodes respectively for KSOM algorithm.

4.4 Evaluation

To check the performance of each method for lifetime and energy consumption, the following values are obtained from the above Figures, in order to compute performance for each method.

lifetime

- At 400 nodes:

Kohenon = 90 rounds

KSOM = 130 rounds

KSOM with conscience function = 150 rounds

- At 800 nodes

Kohenon = 60 rounds

KSOM = 75 rounds

KSOM with conscience function = 80 rounds

Energy Consumption

- At 400 nodes:

Kohenon = 1380 nJ

KSOM = 1350 nJ

KSOM with conscience function = 1310 nJ

- At 800 nodes

Kohenon = 1630 nJ

KSOM = 1600 nJ

KSOM with conscience function = 1550 nJ

In order to compute performance related to normalized value the following shots represent both performance for lifetime and energy consumption.

At 400 nodes

$$performance = \left| \frac{KSOM_{lifetime} - Kohenon_{lifetime}}{KSOM_{lifetime}} \right| = \left| \frac{130 - 90}{130} \right| = 30.7\%$$

$$performance = \left| \frac{KSOM_{with\ conscience\ lifetime} - KSOM_{lifetime}}{KSOM_{with\ conscience\ lifetime}} \right| = \left| \frac{150 - 130}{150} \right|$$

$$= 13.33\%$$

Figure 4. 7: Network lifetime at 400 nodes

At 800 nodes

$$performance = \left| \frac{KSOM_{lifetime} - Kohenon_{lifetime}}{KSOM_{lifetime}} \right| = \left| \frac{75 - 60}{75} \right| = 20\%$$

$$performance = \left| \frac{KSOM_{with\ conscience\ lifetime} - KSOM_{lifetime}}{KSOM_{with\ conscience\ lifetime}} \right| = \left| \frac{80 - 75}{80} \right|$$

$$= 6.25\%$$

Figure 4. 8: Network lifetime at 800 nodes

At 400 nodes

$$performance = \left| \frac{KSOM_{energy} - Kohenon_{energy}}{KSOM_{energy}} \right| = \left| \frac{1350 - 1380}{1350} \right| = 2.22 \%$$

$$performance = \left| \frac{KSOM \text{ with conscience}_{energy} - KSOM_{energy}}{KSOM \text{ with conscience}_{energy}} \right| = \left| \frac{1310 - 1350}{1310} \right|$$

$$= 3.05 \%$$

Figure 4. 9: Network energy consumption at 400 nodes

At 800 nodes

$$performance = \left| \frac{KSOM_{energy} - Kohenon_{energy}}{KSOM_{energy}} \right| = \left| \frac{1600 - 1630}{1600} \right| = 1.875 \%$$

$$performance = \left| \frac{KSOM \text{ with conscience}_{energy} - KSOM_{energy}}{KSOM \text{ with conscience}_{energy}} \right| = \left| \frac{1550 - 1600}{1550} \right|$$

$$= 3.225 \%$$

Figure 4. 10: Network energy consumption at 800 nodes

5 CONCLUSION AND FUTURE WORKS

CHAPTER FIVE

5.1 Conclusion Remarks

To conclude all, WSNs are now widely applied and employed within several critical practical life applications including military fields. Several criteria can be employed in estimating the WSN performance, such as, average energy and lifetime which are considered during this paper. Employing clustering algorithms in distributing nodes within several groups is considered common approach in increasing WSN lifetime and enhances the consumption of energy. Several available clustering algorithms are employed in performing the clustering process. KSOM is one clustering approach that selects the CH for each cluster differently within each round time. In this thesis; the performance of KSOM approach is studied and investigated based on comparing it with Kohonen approach. After simulating the related program of proposed scheme; the results demonstrated that employing KSOM algorithm will result in improving both network lifetime and energy consumption.

The effect of adding conscience function of the neural network considering several numbers of nodes each time was also investigated. The performance has been evaluated considering two main criteria, which are; the average lifetime and the average energy. Three cases were considered during the implementation, which are; SOM, KSOM and KSOM with conscience function of neural network.

The results demonstrated that adding the conscience function to KSOM will enhance the performance of WSN in terms of average lifetime over both SOM and KSOM algorithms. Furthermore; adding the conscience function of NN will also reduce the average value for the consumed energy within the network, which in turns enhance the performance of the whole WSN. So; as a conclusion; it is recommended to employ the conscience function with KSOM algorithm within several applications that are related to WSNs in order to attain the best achievable performance.

5.2 Future Works

Several key points are suggested to improve the proposed system in the future, some of them are;

- Using parallel communication distributed system to increase lifetime .
- Using k med cluster with novel k-mean performance of clustering to increase lifetime .
- Applying the technology KSOM with conscience function for wider area like cites
- Using adaptive resonance theory-NN to increase lifetime and energy consumption.

5.3 Publications

- This work is converted into two papers for publication.
- First paper deals with Kohenon and KSOM.
- Second paper deals with KSOM with Conscience.
- The journal for publication is “European Journal of Scientific Research”
<http://www.europeanjournalofscientificresearch.com/index.html>
- Both papers are accepted.

European Journal of Scientific Research

ISSN: 1460-216X / 1460-202X

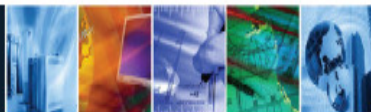

<http://www.europeanjournalofscientificresearch.com>

INITIAL ACCEPTANCE LETTER

Dear Sa'ed Azzam , Prof. Reyadh Naoum, Qais Azzam

After having carefully evaluated your article titled "**Kohenon and Kohenon Self Organizing Mapping Algorithms for Clustering in Wireless Sensor Networks**" and taken the referees' advice into consideration, the editors came to the conclusion that your paper is suitable for publication in our Journal. In order to save time, the referees communicated their opinion to us

European Journal of Scientific Research

ISSN: 1460-216X / 1460-202X



<http://www.europeanjournalofscientificresearch.com>

INITIAL ACCEPTANCE LETTER

Dear Prof. Reyadh Naoum, Sa'ed Azzam, Dr.Sadeq AlHamouz

After having carefully evaluated your article titled "**Performance of Wireless Sensor Networks using Kohenon Self Organizing Mapping Algorithm with Conscience Function**" and taken the referees' advice into consideration, the editors came to the conclusion that your paper is suitable for publication in our Journal. In order to save time, the referees communicated their opinion to us verbally. As part of our evaluation process, we normally ask the opinion of two referees who are experts in the relevant field of research. The paper is also read by the editor. If both of the referees and an editor concur in their view, their decision is final. We

REFERENCES

- [1] Aslam, N, Phillips, W, Robertson, W and Sivakumar, S. 2011. "A multi-criterion optimization technique for energy efficient cluster formation in wireless sensor networks". Science Direct, 12, pp. 202–212
- [2] Lee, S, Yoo, J and Chung, T. (2004). "Distance-based Energy Efficient Clustering for Wireless Sensor Networks".
- [3] Rakocevic, G. (2013). "A Distributed Kohonen Self Organizing Map Applied to Wireless Sensor Networks".
- [4] Azimi, M and Ramezanpor, M. (2012). "A Robust Algorithm for Management of Energy Consumption in Wireless Sensor Networks Using SOM Neural Networks". Journal of Academic and Applied Studies, 2(3), pp. 1-14.
- [5] Veena, K, N and Kumar B, P. (2012). "Dynamic Clustering in Sensor Networks using HMM and Neuro Computation". International Journal of Computer Science and Information Technologies, 3 (4), pp. 4920-4926.
- [6] Mannan, A. (June 2012). "Self Organizing Maps based Life enhancement Framework for Wireless Sensor Networks". International Arab Journal of e-Technology, 2 (4), pp. 223-228.
- [7] Chaczko, Z, Moses, P and Chiu, Ch. (2013). "Cooperative Extended Kohonen Mapping (EKM) for Wireless Sensor Networks".
- [8] Hu, J and Lee, G. (2008). "Distributed Localization of Wireless Sensor Network Using Self-Organizing Maps".
- [9] Yun, S, Youk, Y, Kim, S and Jun, C. (2007). "Study on the Applicability of Self-Organizing Maps to Sensor Network".
- [10] Nurhayati, Choi, S and Lee, K. (2011). "A Cluster Based Energy Efficient Location Routing Protocol in Wireless Sensor Networks".

INTERNATIONAL JOURNAL OF COMPUTERS AND COMMUNICATIONS. 2 (5), pp.64-74.

- [11] Desieno, D. (2013). "ADDING A CONSCIENCE TO COMPETITIVE LEARNING".
- [12] NG, G and TAN, L. (2002). "Conscience algorithm in Neural Network". IEEE. 1, pp. 477 – 481.
- [13] HOSSEINGHOLIZADEH, A. (2009). "A Neural Network approach for Wireless sensor network power management".
- [14] Dehni, L, Kief, F and Bennani, Y. (2005). "Power Control and Clustering in Wireless Sensor Networks. Journal of Challenges in Ad Hoc Networking". pp.31-40.
- [15] W, Al-Rashdan, R, Naoum, W, Al_Sharafat and M, Alkhazaaleh. November 2010. " Novel Network Intrusion Detection System using Hybrid Neural Network (Hopfield and Kohonen SOM with Conscience Function)". IJCSNS International Journal of Computer Science and Network Security, 10 (11), pp. 10-13.
- [16] T, Taner. (1997). " Kohonen's Self Organizing Network with conscience".
- [17] R, Silva. (2003). " Improved Self-Organizing Map Performance applied to Process Monitoring".
- [18] K, Tasdemir, E and Merényi. (2012). " SOM-based topology visualization for interactive analysis of high-dimensional large datasets".
- [19] X, Xiao, D, Dow, R, Eberhart, Z, Miled and R, Oppelt . (2003)." Gene Clustering Using Self-Organizing Maps and Particle Swarm Optimization".

- [20] B, Bhuvana. (2014). "Comparison of Simple Clustering by Self-Organizing Maps Using Neural Network Clustering Tool", Middle-East Journal of Scientific Research, 20 (12), pp. 2367-2372
- [21] M, Johnsson, Ch, Balkenius and G, Hesslow. (2009). "ASSOCIATIVE SELF-ORGANIZING MAP". in the proceedings of the International Joint Conference on Computational Intelligence (IJCCI) 2009. Funchal, Madeira, Portugal, pp. 363-370.
- [22] M. I. Khan. (2007). "Congestion Avoidance and Energy Efficient Routing Protocol for Wireless Sensor Networks with a Mobile Sink". Journal of Networks. 2 (6). Pp. 42-49.
- [23] K. Karenos, V. Kalogeraki and S. V. Krishnamurthy. (2005). "Cluster-based Congestion Control for Supporting Multiple Classes of Traffic in Sensor Networks". Embedded Networked Sensors, 2005. EmNetS-II. The Second IEEE Workshop on. Pp. 107-114.
- [24] H. Mohajerzadeh and M. H. Yaghmaee. (2010). "Tree Based Energy and Congestion Aware Routing Protocol for Wireless Sensor Networks". Pp. 161-167.
- [25] M. Cherian and G. Nair. (2011). "Multipath Routing With Novel Packet Scheduling Approach In Wireless Sensor Networks". International Journal of Computer Theory and Engineering. 3 (5). Pp. 666-670.
- [26] K. Karenos, V. Kalogeraki and S. V. Krishnamurthy. (2007). "Cluster based Congestion Control for Sensor Networks". ACM Transactions on Sensor Networks. Pp. 1-31.
- [27] S. Jabbar, A. Ahmad, A. A. Ikram and M. Khan. (2011). "TSEEC -

- TS/TDMA based Energy Efficient Congestion Control in Mobile Wireless Sensor Network”. Proceedings of the World Congress on Engineering and Computer Science.
- [28] Q. Pang, V. W. S. Wong and V. C. M. Leung. (2008). “Reliable data transport and congestion control in wireless sensor networks”. *Int. J. Sensor Networks*. 3 (1). Pp.16–24.
- [29] V. Vijayaraja and R. R. Hemamalini. (2010). “Congestion in Wireless Sensor Networks and Various Techniques for Mitigating Congestion - A Review “.International Conference on Computational Intelligence and Computing Research.
- [30] M. Faheem, A. B. Ngadi, S. Ali, M.A.Shahid and L.Sakar. (2013). “Energy based Efficiency Evaluation of Cluster-Based Routing Protocols for Wireless Sensor Networks (WSNs)”. *International Journal of Software Engineering and Its Applications*. 7 (6). Pp. 249-264.
- [31] R. Chakravarthi. (2012). “A Fuzzy Approach to Detect and Control Congestion in Wireless Sensor Networks”. *Indian Journal of Computer Science and Engineering (IJCSE)*. 3 (3). Pp.476-483.
- [32] N. Enami, N. Charkari, K. Ahmadi. (2011). “Intelligent Clustering for Balanced Energy Consumption in Wireless Sensor Networks”. *International Journal of Advancements in Computing Technology*, 3 (2). Pp.16-23.
- [33] N. Aslam, W. Phillips, W. Robertson and S. Sivakumar. (2012). “A multi-criterion optimization technique for energy efficient cluster formation in wireless sensor networks”. *Science Direct*. 12. Pp. 202–212.
- [34] M. Turhan. (1997). “Kohenon Self Organizing Network with

Conscience”.

- [35] T.L. Saati. 1990. “How to make a decision: The Analytic Hierarchy Process”. *European Journal of Operational Research*, 48 (1), pp.4-26.
- [36] N. Enami, R.Moghadam, K.Dadashtabar. (2010).” NEURAL NETWORK BASED ENERGY EFFICIENCY IN WIRELESS SENSOR NETWORKS: A SURVEY”. *International Journal of Computer Science & Engineering Survey (IJCSSES)*. 1(1). Pp.40-55.
- [37] Rathi and Viswanathan (2014). ” TWO PHASE CLUSTERING METHOD FOR LEACH PROTOCOL FOR EFFECTIVE CLUSTER HEAD SELECTION”. *Journal of Computer Science* 10 (3): 366-375, 2014. Pp.366-375.
- [38] Melody Y. Kiang (2201). ” Extending the Kohonen self-organizing map networks for clustering analysis ”. *Computational Statistics & Data Analysis* 38 (2001) 161–180. Pp.161-180.
- [39] R. A., Ramadana, F, Medhat and I, Talkhanc. 2013. “K-Means for Efficient Clustering in Multimodal WSNs”. *Information Engineering Letters*. 3 (2),pp. 35-43
- [40] R, Abrishambaf, S. N, Bayindir and M, Hashemipour. 2011. “Energy analysis of routing protocols in wireless sensor networks for industrial applications”. *J Systems and Control Engineering*. pp. 1-8